

TECHNICAL INFORMATION

This information is intended to provide the specifier or contractor with guidance on all aspects of Marshall-Tufflex cable management products.

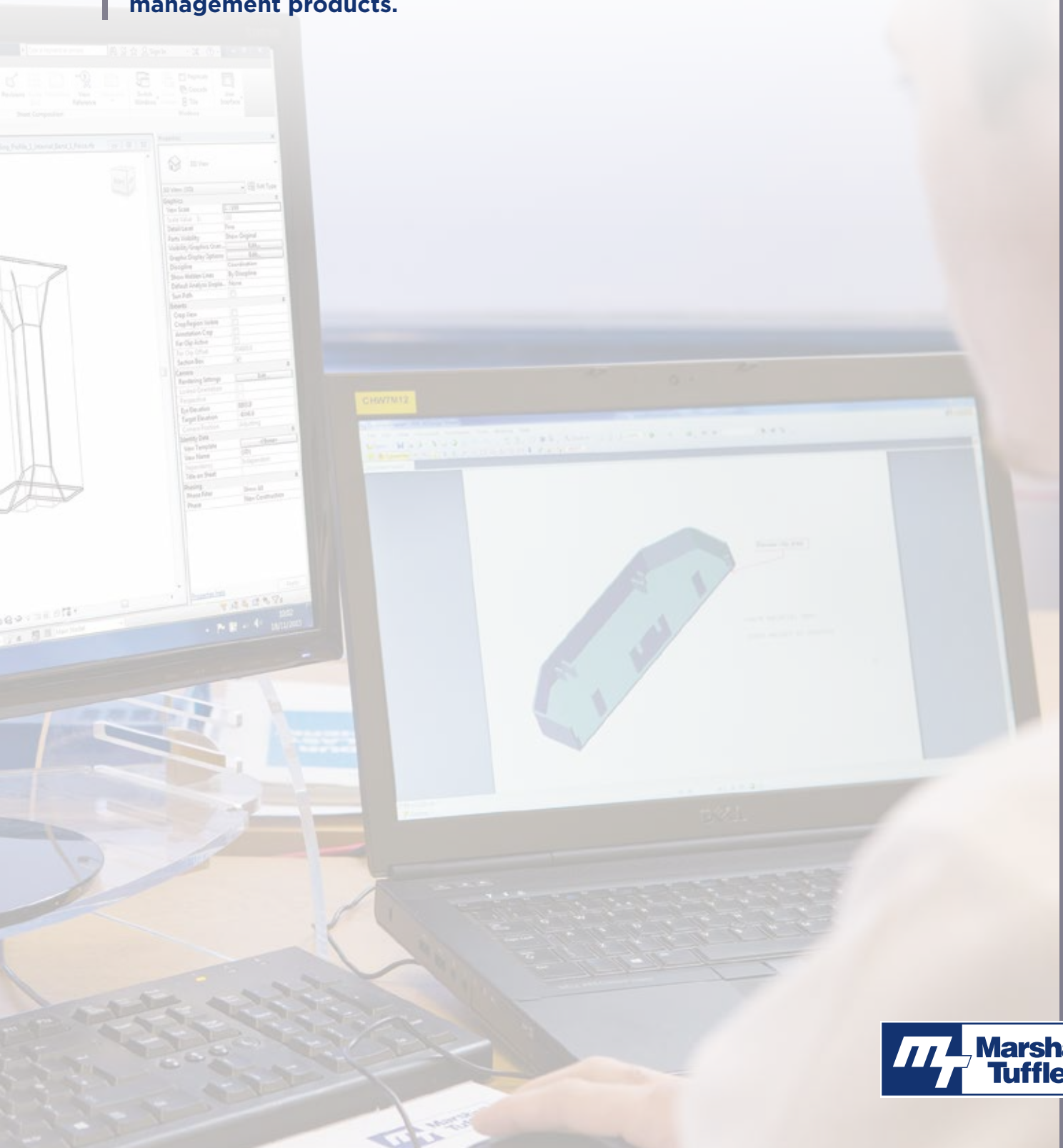

Contents

Material data	237
Data compliant trunking	242
PVC-U perimeter trunking systems	244
• Mono and Mono Plus	245
• Compact	246
• Twin165	247
• Sterling Profile	248
• Sterling Curve	248
• Odyssey	250
• Twin Plus	251
• XL trunking	252
PVC-U trunking	254
• Mini trunking	254
• Maxi trunking	255
• Cornice trunking	257
• Sovereign Plus trunking	258
• Sceptre trunking	255
• Bench trunking	259
Accessory boxes, plates and enclosures	260
Conduit systems	262
• PVC-U conduit	262
• MT Supertube	262
Fire and safety systems	263
• Callmaster	263
• Firefly	263
Aluminium trunking systems	266
• Bench trunking	267
• Elegance	268
• Sterling Profile	269
• Sterling Curve	269
• Twin Plus	271
• XL trunking	272
Steel trunking systems	273
PowerPoles and PowerPosts	274
• PowerPoles	274
• PowerPosts	276
Underfloor to desk solutions	277
• MT32 underfloor system	277
• Powertrack, boxes and grommets	278
• Power and data modules	282
GRP ladder and tray	283
Wire basket	287
Laboratory and healthcare	293
• Bio antimicrobial trunking	293

PVC-U material data

Marshall-Tufflex cable management products are manufactured in Extra Super High Impact PVC-U grade material, capable of withstanding the most hazardous conditions on site and which exceeds the most stringent requirements of the British Standards.

Characteristics

Specific gravity		1.42
Co Efficient of Linear Expansion		$7 \times 10^{-5}/m^{\circ}C$
Water Absorption		Negligible
Electric Strength		To the requirements of BS EN 50085 and BS IEC 61084
Fire Performance	BS 476 PT6 & PT7 BS EN 50085 UL94 BS EN 61386-1 BS 4607 BS IEC 61084	PASS PASS V-0 @1.6mm PASS PASS PASS
Oxygen Index		42%
Tensile Strength		492/562 kg/cm ²
Insulation Resistance		To the requirements of BS 4607, BS EN 50085, BS EN 61386-1 BS IEC 61084
Chemical Resistance		See below
Vicat Softening Point (conduit & trunking)		80°C BS EN ISO 306
Vicat Softening Point (moulded fittings)		76°C BS EN ISO 306



Our PVC-U products are manufactured from an average of 80% recycled plastic, with some extruded products produced from 100% recycled material. The index at the back of the catalogue details the recycled content by individual product.

Chemical resistance

The material is virtually unaffected by solutions of inorganic acids, alkalis and salts and is resistant to many organic chemicals. It may be softened by some organic materials such as ketones and aromatic compounds. It will not corrode. See Chemical Resistance table on page 237 for further details.

Fire resistance

The material used in Marshall-Tufflex conduit and trunking are self-extinguishing and comply with the requirements of BS 476 Parts 6 and 7 and BS 4678. Non-flame propagating to BS EN 50085, BS IEC 61084 and BS EN 61386-1.

(See Characteristics table above)

Thermal properties

Marshall-Tufflex conduit and trunking is designed to accommodate variations of ambient temperature equating to 5.25mm/3m for a temperature rise of 25°C.

Operating temperatures: -5°C to +60°C.
Thermal conductivity: 0.19 w/m²°C.

Impact resistance

High impact resistance. The material is formulated to comply with the -5°C Heavy Gauge Requirements of BS EN 61386-1.

Standards

Trunking systems are manufactured to comply with the requirements of BS EN 50085-1:2005+A1:2013, BS IEC 61084-1:2017 where applicable. Conduit systems comply with the requirements of BS 4607-5: 1982+A3:2010 and BS EN 61386-1:2008.

PVC-U chemical resistance table

The resistance of unplasticised PVC-U to a wide range of chemicals is listed in the following table.

The symbols used to denote performance are as follows:

✓ Satisfactory

Some attack or absorption: the material may be considered for use when alternative materials are unsatisfactory and where limited life is acceptable. When PVC is to be used with such chemicals, full scale trials under realistic conditions are necessary.

≈ Unsatisfactory: so rated because of decomposition, solution, swelling loss of ductility etc, of the samples tested.

For clarification and for details of resistance to other chemicals please call our Technical Team on +44 (0)1424 856688.

Note: To determine the suitability of PVC-U for external applications we strongly recommend you contact our Technical Team on +44 (0)1424 856688.

Chemical	Concentration	Unplasticised PVC	
		20°C	60°C
acetaldehyde	40% aq. solution	✓	≈
acetic acid	60% aq. solution	✓	✓
acetic anhydride		≈	≈
acetone	Traces	≈	≈
alcohol, ethyl	40% w/w water	✓	#
alcohol, isopropyl		✓	✓
alcohol, menthyl	6% aq. solution	✓	✓
	100%	✓	#
aliphatic hydrocarbons		✓	✓
aluminium chloride		✓	✓
aluminium hydroxide		✓	✓
ammonia	0,88S.G., aq solution	✓	✓
	Anhydrous gas	≈	≈
	Anhydrous liquid	≈	≈
ammonium chloride		✓	✓
ammonium hydroxide		✓	✓
aniline		≈	≈
animal oils		✓	✓
aqua regia	Dilute	✓	✓
	Concentrated	✓	≈
barium sulphate		✓	✓
beer		✓	
benzene		≈	≈
benzoyl chloride		≈	≈
borax		✓	✓
boric acid		✓	✓
brine		✓	✓
bromide	Traces, gas	#	≈
	100% (dry gas)	≈	≈
	Liquid	≈	≈
calcium chloride	Aq. solution	✓	✓
	20% in methyl alcohol	✓	

Chemical	Concentration	Unplasticised PVC	
		20°C	60°C
calcium hydroxide		✓	✓
calcium hypochlorite		✓	✓
carbon dioxide		✓	✓
carbonic acid		✓	✓
carbon monoxide		✓	✓
carbon tetrachloride		#	≈
castor oil		✓	
chloric acid		✓	
chlorine	100% (dry gas)	✓	#
	10% (moist gas)	#	
chlorine water	Sat. solution	#	#
chloroform		≈	≈
chrome alum		✓	✓
chromic acid	Plating solution	✓	✓
cider		✓	
citric acid		✓	✓
copper chloride		✓	✓
copper cyanide		✓	✓
copper nitrate		✓	✓
copper sulphate		✓	✓
cyclohexanone		≈	≈
detergent, synthetic	All concentrations	✓	✓
developers, photographic		✓	✓
dextrin		✓	✓
dextrose		✓	✓
diazo salts		✓	✓
dichlorodifluoromethane		✓	
diethyl ether		≈	≈
emulsifiers	All concentrations	✓	✓
emulsions, photographic		✓	✓
ethyl acetate		≈	≈
ethylene glycol		✓	✓
ethylene oxide		≈	≈
fatty acids		✓	✓
ferric chloride		✓	✓
ferric nitrate		✓	✓
ferric sulphate		✓	✓
ferric ammonium citrate		✓	✓
ferrous chloride		✓	✓
ferrous sulphate		✓	✓
fixing solution, photographic		✓	✓
fluorine		#	#
formaldehyde	40% w/w water	✓	✓
formic acid	50% solution	✓	#
	100% solution	✓	≈
fructose		✓	✓
fruit pulp		✓	✓
glucose		✓	✓
glycerol		✓	✓
grape sugar		✓	✓
heptane		✓	✓
hydrobromic acid	100%	✓	✓
hydrochloric acid	22% aq. solution	✓	✓
	concentrated	✓	✓
hydrochloric acid	40% aq. solution	✓	#
	60% aq. solution	#	≈
	concentrated	≈	≈

Chemical	Concentration	Unplasticised PVC		Chemical	Concentration	Unplasticised PVC	
		20°C	60°C			20°C	60°C
hydrogen bromide	anhydrous	✓	✓	propylene glycol		✓	✓
hydrogen chloride	anhydrous	✓	✓	propylene oxide		≈	≈
hydrogen fluoride	anhydrous	✓	✓	saccharose		✓	✓
hydrogen peroxide	3% (10vol)	✓	✓	sea water		✓	✓
	12% (40 vol)	✓	✓	silver nitrate		✓	✓
	30% (100 vol)	✓	✓	soap solution		✓	✓
	90% and above	✓	✓	sodium bicarbonate		✓	✓
hydrogen sulphide		✓	✓	sodium bisulphite		✓	✓
iodine	solution in potassium iodide	≈	≈	sodium borate		✓	✓
lactic acid	10% aq. solution	✓	✓	sodium bromide		✓	✓
	100%	≈	≈	sodium carbonate		✓	✓
lanoline		✓	✓	sodium chlorate		✓	✓
linoleic acid		✓	✓	sodium chloride		✓	✓
linseed oil		✓	✓	sodium cyanide		✓	✓
magnesium hydroxide		✓	✓	sodium ferricyanide		✓	✓
maleric acid	50% aq. solution	✓		sodium ferrocyanide		✓	✓
	concentrated	✓	#	sodium fluoride		✓	✓
metallic soaps (water soluble)		✓	✓	sodium hydroxide	40% aq. solution	✓	✓
methyl bromide		≈	≈		concentrated	✓	✓
methyl chloride		≈	≈	sodium hypochlorite 15%Cl		✓	✓
methyl cyclohexanone		≈	≈	sodium hyposulphate		✓	✓
methyl ethyl ketone		≈	≈	sodium nitrate		✓	✓
methyl isobutyl ketone		≈	≈	sodium peroxide		✓	✓
methylated spirit		✓	✓	sodium silicate		✓	✓
methylene chloride		≈	≈	sodium sulphate		✓	✓
milk		✓	✓	sodium sulphide	25% aq. solution	✓	✓
mineral oil		✓	✓		concentration	✓	✓
mixed acids	(sulphic/nitric various proportions)	#	≈	sodium sulphite		✓	✓
molasses		✓	✓	soft soap		✓	✓
naptha		✓	✓	surface active agents All concentrations (emulsifiers, synthetic detergents and wetting agents)		✓	✓
napthalene		≈	≈	starch		✓	✓
nicotine		✓	✓	stearic acid		✓	✓
nitric acid	5% aq. solution	✓		sucrose		✓	✓
	50% aq. solution	✓	#	sulphur	Colloidal	✓	✓
nitrobenzene		≈	≈	sulphur dioxide	Dry	✓	✓
oleic acid		✓	✓		Liquid	#	≈
oxalic acid		✓	✓	sulphuric acid	80% aq. solution	✓	✓
oxygen		✓	✓		90% aq. solution	✓	#
ozone		✓	✓		Fuming	≈	≈
paraffin		✓	✓	sulphurous acid	10% aq. solution	✓	✓
pentane		✓		tallow		✓	✓
petrol		✓	✓	tanning extracts		✓	✓
phosphoric acid	30% aq. solution	✓	✓	tartaric acid		✓	✓
	95% aq. solution	✓	✓	transformer oil		✓	✓
photographic developers		✓	✓	trichloroethane		≈	≈
potassium bromide		✓	✓	trichloroethylene		≈	≈
potassium carbonate		✓	✓	turpentine		✓	✓
potassium cyanide		✓	✓	vegetable oils		✓	✓
potassium ferricyanide		✓	✓	vinegar		✓	✓
potassium				water		✓	✓
hydroxide	10% aq. solution	✓	✓	wetting agents	All concentrations	✓	✓
	concentrated	✓	✓	wines and spirits		✓	
potassium hypochlorite		✓	✓	xylene		≈	≈
potassium permanganate		✓	✓	zinc carbonate		✓	✓
propane		✓		zinc chloride		✓	✓
				zinc sulphide		✓	✓

Polycarbonate material data

Chemical resistance

Polycarbonate is resistant to most mineral and organic acids, a number of fats and oils, saturated aliphatic and aromatic hydrocarbons and alcohols, with the exception of methyl alcohol. It is not resistant to alkalis, ammonia gas and its solution or to amines.

Characteristics

Vicat softening point – ISO 306	VST/B 145°C
Flammability to UL94 @ 1.5mm	94V-2
Flammability – oxygen index	35%
Density	1.2g/cm3
Water absorption (in water)	0.35%

ABS high impact FR material data

Fire Retardant (FR) ABS has a good chemical resistance to inorganic salt solutions, alkalis, mineral acids (except strong oxidising acids) and some mineral, vegetable and animal based oils. It is attacked by organic solvents such as alcohols, esters, ketones and ethers.

Characteristics

Vicat softening point	ISO 306	96°C
Density	1.18g/cm³	
Material	UL listed	
Fire performance	BS 4678 BS EN 50085 UL94	PASS PASS V-O @ 1.6mm
Water absorption (in water)	DIN53495/L	0.3%

Aluminium material data

Grade HE9TF: Screen Insert.

Grade 6063T5: Series 2 PowerPole and PowerPost, Bench Trunking Aluminium, Sterling Profile Aluminium, XL Aluminium, Twin Plus Aluminium.

Grade 6060T5: Elegance 170.

Tensile strength: 190N/mm²

Co Efficient of linear expansion: 24 x 10⁻⁶/m°C.

Thermal conductivity: 120w/m°C.

GRP ladder and tray material data

Fire behaviour

Properties	Standard references	Press Moulded Fittings	Pultruded Extrusions	Units
Flammability	ASTM D 6194 / IEC 60695-2-12 Glow-wire flammability index (GWFI) test method for materials.	960	960	°C
Flammability	UL 94 Test for flammability of plastic materials.	V0	V0	-
Fire propagation	NF P 92-501 Fire behaviour of building materials.	Not tested	Not tested	-
Flame spread & smoke developed index	ASTM E84 / UL 723	FSI = 25	FSI = 35	Index
	Surface burning characteristics of building materials. Class following the Uniform Building Code.	SDI = 350 Class I	SDI = 450 Class II	Index -
Flammability & smoke index	NF F 16-101	I2	I2	Index
	Fire behaviour of materials for rolling stock.	F0	F1	Index
Limiting oxygen index	ASTM D 2863 / ISO 4589-2 Plastics - Determination of burning behaviour by oxygen index. Part 2 : Ambient - temperature test.	> 32%	> 32%	%
Flammability & smoke index	VKF Materials and building parts. Part B : Test methods.	5.3	5.3	Index
Fire behaviour	DIN 4102-1 Fire behaviour of building materials and elements. Part 1: Classification of building materials.	B2	B2	-
Fire behaviour	DIN 5510-2 Preventive fire protection in railway vehicles.	S4 / SR2 / ST2	S4 / SR2 / ST2	Index
	Part 2 : Fire behaviour and fire side effects of materials and parts.	FED(30 min.) = 0,09	FED(30 min.) = 0,04	Index
	Appendix C : FED (30 min.) < 1			
Fire behaviour	EN 45545-2 Railway applications - Fire protection on railway vehicles. Part 2 : Requirements for fire behaviour of materials and components. Applicable requirement : R6	None	None	HL
	ISO 5660-1 Parameter MARHE	103,7	101,3	kW/m²
	EN ISO 5659-2 (50 kW/m²) Parameter DS(4)	376,2	331,2	-
	EN ISO 5659-2 (50 kW/m²) Parameter VOF4	454,6	488,5	-
Fire behaviour	EN 45545-2 Appendix C (50kW/m²) Parameter CITG at 4 min.	0,016	0,015	-
	EN 45545-2 Appendix C (50kW/m²) Parameter CITG at 8 min.	0,068	0,064	-

GRP ladder and tray material data – continued

Mechanical behaviour

Properties	Standard references	Press Moulded Fittings	Pultruded Extrusions	Units
Tensile strength at break point	ISO 527-5 Plastics - Determination of tensile properties. Part 5 : Unidirectional fibre-reinforced plastic composites.	~ 55	~ 187	MPa
Tensile modulus	ISO 527-5 Plastics - Determination of tensile properties. Part 5 : Unidirectional fibre-reinforced plastic composites.	~ 7200	~ 11900	MPa
Accelerated ageing test by UV exposure	ISO 4892-2 / ISO 527-5 Methods of exposure to laboratory light sources - Part 2 : Xenon-arc sources.	Good mechanical and chromatic behaviour	Good mechanical and chromatic behaviour	-
Accelerated ageing test by salt spray exposure	ISO 9227 / ISO 527-5 Corrosion tests in artificial atmospheres - Salt spray tests.	Good mechanical and chromatic behaviour	Good mechanical and chromatic behaviour	-
Accelerated ageing test by UV and salt spray exposure	ISO 4892-2 / ISO 9227 / ISO 527-5 UV and salt spray exposure.	Good mechanical and chromatic behaviour	Good mechanical and chromatic behaviour	-

Electrical behaviour

Properties	Standard references	Press Moulded Fittings	Pultruded Extrusions	Units
Measure of surface resistivity & discharge	IEC 60079-0 Explosive atmospheres.	~ 4.10 ⁹	> 10 ¹¹	Ω
	Part 0 : Equipment - General requirements.	IIA, IIB, IIC	IIA, IIB, IIC	-
Dielectric strength	IEC 60243-1 Electric strength of insulating materials. Part 1 : Tests at power frequencies.	~ 6,5	Not tested	kV/mm
Proof tracking index	IEC 60112 Method for the determination of the proof and the comparative tracking indices of solid insulating materials.	575	600	V

Marine approval

Properties	Standard references	Press Moulded Fittings	Pultruded Extrusions	Units
Approval for vessels and drilling platforms	ABS (American Bureau of Shipping)	KK Approved	UL Approved	

Others

Properties	Standard references	Press Moulded Fittings	Pultruded Extrusions	Units
Density		1,8	1,8	g/cm3
Thermal conductivity		0,3	0,3	W/m.K
Coefficient of linear thermal expansion	ISO 11359-2 Plastics - Thermo mechanical analysis (TMA). Part 2 : Determination of coefficient of linear thermal expansion.	~ 36 x 10-6	~ 10 x 10-6	cm/cm/K
Water absorption	ISO 62 Plastics - Determination of water absorption.	0,16	0,3	%
Glass content		> 20%	> 45%	%
Linear shrinkage		0,1	0,1	%
Rockwell hardness		not tested	not tested	HRm
Barcol hardness		> 50	> 50	Barcol
Material temperature range*		-80°C to +130°C	-80°C to +130°C	°C
Continuous operating temperature range		-50°C to +80°C	-50°C to +80°C	°C
Material resistance to high temperatures		good, no flexion	good, no flexion	°C

* Reduced mechanical resistance when ambient temperature is increasing.

GRP Material Chemical Resistance Table

Chemical	Concentration	Performance
Water	-	Good Performance
Acids	10%	Medium Performance
Base	10%	Good Performance
Ethanol	-	Good Performance
Benzine	-	Good Performance
Benzol	-	Medium Performance
Mineral Oil	-	Good Performance
Vegetable and animal fat	-	Good Performance
Chemical products	-	Good Performance

Storage of GRP material

It is best to store GRP products prior to installation at temperatures higher than 0°C and less than 40°C. However the GRP products may be stored at temperatures between -60°C to over 130°C

Information on recycling and environmental impact for the GRP products

Thermoset composite material is made of glass and polyester resin. It can be recycled in waste treatment stations for a further waste processing. This material is inert and has no environmental impact as GRP waste can be re-used in outside applications as raw material for the road building or in cement production.

GRP cable ladders pultruded

Resin types (all zero halogen)

Polyester (standard)	good all round performance, mechanical strength, corrosion resistance, fire behaviour, temperature rating
Acrylic (on request)	excellent resistance to fire in a corrosive environment
Vymilester (on request)	highly resistant to a specific range of chemical agents (H2SO4HCl...)
Carbon loaded polyester (on request)	antistatic properties for highly explosive atmospheres

Power and data segregation

It is important when installing power and data cables in the same installation that the installation complies with the relevant standard. If any conflicts in separation distances arise then the greater separation distance must always apply. To comply with the correct separation distance between power and data cables please refer to BS EN 50174-2:2009+A2:2014 section 6.

There are a number of factors that will affect the separation distance of power and data cables these are listed below:

- Total number of power circuits
- The total load on the power circuit
- The type of data cable being installed
- The installation method of the power and data cables

Every installation is different so it is important to refer to the installation standard for each installation to ensure compliance.

Types of data cable – different categories of cable

Data cables are classified in a number of different categories such as Cat 5e and Cat 6 etc. Generally speaking the higher the category number the higher the performance specification. Data cable is backwards compatible so a Cat 6 installation will always perform to a higher specification than a Cat 5 installation. The basic principle of data cable is very similar across all the different categories and is based on 4 pair twisted cable which is shielded to protect from external EMI and alien or cross talk interference from adjacent cables.

Understanding segregation methods

Incorrect installation		All cables installed in same compartment with no separation.
Correct installation		Cables separated by means of physical barrier in accordance with BS EN 50174-2:2009+A2:2014 section 6
		Cables separated by minimum distance in accordance with BS EN 50174-2:2009+A2:2014 section 6
Key		

Data cable comparison table

Data Cable type	*Cable diameter	Frequency	Speed	Notes
Cat 5e	6mm	Up to 100MHz	Up to 1000MBps	Cat 5e has its limitations and will not be able to support emerging 10GBase-T Ethernet
Cat 6	7.2mm	Up to 250MHz	Up to 10GBps	Cat 6 will run at a much higher performance than Cat 5e supporting more than double the speed and frequency, running to a much tighter specification.
Cat 6a	7.4mm	Up to 500MHz	Up to 10GBps	Cat 6a is designed to support 10GBase-T over a maximum distance of 100 metres.
Cat 7	7.9mm	Up to 600MHz	Up to 10GBps	Cat 7 and Cat 7a data cables are shielded including both the individual cables and the overall cables being screened.
Cat 7a	8.2mm	Up to 1000MHz	Up to 10GBps	

*Please note that cable diameters have been calculated on an average figure from a range of data cable manufacturers.

45% Cable capacity

It is important to follow the Wiring Regulations when installing cables in trunking. By following the Wiring Regulations you minimise the potential of heat rise and cable damage and maintain data throughput when installing new circuits. For further information on trunking cable capacity and grouping factors please refer to the current version of the BS 7671 Wiring Regulations.

Conductor type	Size	Cable factor
Stranded PVC power	1.5mm ²	8.6
Stranded PVC power	2.5mm ²	12.6
Stranded PVC power	4.0mm ²	16.6
*Data cable	Ø5.5mm	23.8
*Data cable	Ø6.0mm	28.3
*Data cable	Ø6.5mm	33.2
*Data cable	Ø7.0mm	38.5
*Data cable	Ø8.4mm	55.4

Please note that made to order fabricated fittings can be manufactured to meet your Cat 7a data cable minimum bend radius. Please contact our technical department on +44 (0)1424 856688 for further information.

Marshall-Tufflex cable management systems are suitable for a variety of data category cables.

The information in the table below is based on average data cable diameters taken from a number of data cable manufacturers.

In all cases it is highly recommended to contact the data cable manufacturer to confirm the specification and minimum bend radius of the data cable prior to installation.

Guidance to determine minimum bend radius

Data Cable	Un-Shielded	Shielded
Cat 5	Up to 10 x cable diameter	-
Cat 5e	Up to 10 x cable diameter	Up to 7 x cable diameter
Cat 6	Up to 8 x cable diameter	Up to 7 x cable diameter
Cat 6a	Up to 8 x cable diameter	Up to 6 x cable diameter
Cat 7	-	Up to 6 x cable diameter
Cat 7a	-	Up to 6 x cable diameter

Installation guidance laying vs pulling

It is important to consider the installation method prior to installing data cables. Incorrect method or poor installation techniques can alter the cable characteristics and degrade the overall specification of the data cable. When pulling cables into trunking systems it is important to note the manufacturer's maximum pulling force as this can reduce the minimum bend radii of the data cable. Laying data cables into a trunking system ensures that minimum bend radius can be achieved and that the data cables installed complies with the required specifications for the installation.

Shielding

The shielding of data cables is important as this stops the signal generated within the data cable radiating and interfering with signals in nearby cables and circuitry. The shielding also protects the signal from surrounding cables and other external influences. The two main types of shielding material are metallic foil and metallic braid. A number of factors should be considered before selecting the type of shielding for an installation.

- The flexibility of the data cable
- The mechanical strength
- The required shield effectiveness
- Ease of stripping and terminating

Once the correct type of shielding has been selected it is important that the shielding is bonded correctly for it to be effective in protecting against signal interference.

Data cable types advantages/disadvantages

Advantages

- Screened cables offer better protection against electromagnetic interference compared to un-screened data cables.
- Screened and unshielded cables work fine at 1Gigabit Ethernet data rates but screened data cables will outperform at data rates such as 10Gigabit due to their ability to support higher frequency transmissions

Disadvantages

- Unshielded data cables require a physical barrier and or separation distance between power cables must be increased.

Data aperture sizes – LJ6C and Euro modules

LJ6C data modules are suitable for use in trunking systems, floor boxes or any systems that has an industry standard LJ6C aperture. The aperture size for the LJ6C module is 22mm x 37mm but may differ slightly between manufacturers. The Euro data modules have a slightly larger aperture at 25mm x 50mm. Coordinating accessory plates can accommodate one or multiple Euro data modules.

PVC-U vs aluminium trunking advantages/disadvantages

PVC-U trunking systems are low cost, light weight and can be easily fabricated whilst on site, however PVC-U is a non-conductive material so offers no protection against EMI. When using a PVC-U trunking for data installation it is important to segregate and screen the data cables from power and control cables.

This can be easily overcome by either using our range of conductive copper sprayed multi compartment trunking systems or by using the steel screening divider. Steel screening dividing strips can be easily retro fitted to an existing PVC-U trunking installation.

Aluminium trunking systems are lightweight and easy to handle and have high impact and mechanical strength compared to a PVC-U trunking installation. Aluminium trunking systems offer great protection against EMI especially at higher frequencies. Both material options aid and support compliant installations.

PVC-U perimeter trunking capacity guide

Trunking height up to 150mm

MONO 10 – no box
 1 = 4141mm² total area
 1 = 1863mm² 45% space factor
With box in comp 1
 1 = 1874mm² total area
 1 = 843mm² 45% space factor
Internal dimensions
 Compartment 1 = 96 x 46mm

COMPACT 1 – no box
 1 = 1280mm² total area
 1 = 576mm² 45% space factor
 2 = 3763mm² total area
 2 = 1693mm² 45% space factor
With box in comp 2
 2 = 1497mm² total area
 2 = 673mm² 45% space factor
Internal dimensions
 Compartment 1 = 36 x 45mm
 Compartment 2 = 87 x 46mm

COMPACT 2 no box
 1 = 1534mm² total area
 1 = 690mm² 45% space factor
 2 = 3763mm² total area
 2 = 1693mm² 45% space factor
With box in comp 2
 2 = 1497mm² total area
 2 = 673mm² 45% space factor
Internal dimensions
 Compartment 1 = 36 x 45mm
 Compartment 2 = 87 x 46mm

MONO PLUS 20 – no box
 1 & 3 = 1024mm² total area
 1 & 3 = 461mm² 45% space factor
 2 = 3451mm² total area
 2 = 1553mm² 45% space factor
With box in comp 2
 2 = 1185mm² total area
 2 = 533mm² 45% total area
Internal dimensions
 Compartment 1 = 27 x 45mm
 Compartment 2 = 77 x 46mm
 Compartment 3 = 27 x 45mm

STERLING CURVE PROFILE 1 – no box
 1 & 3 = 1170mm² total area
 1 & 3 = 527mm² 45% space factor
 2 = 3858mm² total area
 2 = 1736mm² 45% space factor
With box in comp 2
 2 = 1376mm² total area
 2 = 619mm² 45% total area
Internal dimensions
 Compartment 1 = 39 x 45mm
 Compartment 2 = 86 x 46mm
 Compartment 3 = 39 x 45mm

STERLING CURVE PROFILE 2 – no box
 1 = 1170mm² total area
 1 = 527mm² 45% space factor
 2 = 3858mm² total area
 2 = 1736mm² 45% space factor
 3 = 1542mm² total area
 3 = 694mm² 45% space factor
With box in comp 2
 2 = 1376mm² total area
 2 = 619mm² 45% space factor
Internal dimensions
 Compartment 1 = 39 x 45mm
 Compartment 2 = 86 x 46mm
 Compartment 3 = 39 x 45mm

Trunking height from 150mm to 200mm

TWIN165 – no box
 1 = 3272mm² total area
 1 = 1472mm² 45% space factor
 2 = 5404mm² total area
 2 = 2431mm² 45% space factor
With box in comp 2
 2 = 3100mm² total area
 2 = 1395mm² 45% space factor
Internal dimensions
 Compartment 1 = 58 x 61mm
 Compartment 2 = 94 x 61mm

STERLING PROFILE 2 – no box
 1 = 1266mm² total area
 1 = 570mm² 45% space factor
 2 = 3858mm² total area
 2 = 1736mm² 45% space factor
 3 = 1542mm² total area
 3 = 694mm² 45% space factor
With box in comp 2
 2 = 1376mm² total area
 2 = 619mm² 45% space factor
Internal dimensions
 Compartment 1 = 39 x 45mm
 Compartment 2 = 86 x 46mm
 Compartment 3 = 39 x 45mm

ODYSSEY – no box
 1 & 3 = 1256mm² total area
 1 & 3 = 565mm² 45% space factor
 2 = 4022mm² 45% total area
 2 = 1810mm² 45% space factor
With box in comp 2
 2 = 1230mm² total area
 2 = 554mm² 45% space factor
Internal dimensions
 Compartment 1 = 36 x 46mm
 Compartment 2 = 81 x 48mm
 Compartment 3 = 36 x 46mm

COMPACT 3 – no box
 1 = 3763mm² total area
 1 = 1693mm² 45% space factor
 2 = 3700mm² total area
 2 = 1665mm² 45% space factor
With box in comps 1 and 2
 1 = 1503mm² total area
 1 = 676mm² 45% space factor
 2 = 1440mm² total area
 2 = 648mm² 45% space factor
Internal dimensions
 Compartment 1 = 87 x 45mm
 Compartment 2 = 87 x 46mm

Conductor type	Size	Cable factor
Stranded PVC power	1.5mm ²	8.6
Stranded PVC power	2.5mm ²	12.6
Stranded PVC power	4.0mm ²	16.6

For Data cable information, please see page 242

Other Sterling Profile dimensions

Other Sterling Profiles are a combination of the ones shown on this page and can be calculated using the compartment dimensions shown here.

Trunking height over 200mm

TWIN PLUS – no box
 1 & 2 = 4755mm² total area
 1 & 2 = 2140mm² 45% space factor
With box in comps 1 or 2
 1 & 2 = 2431mm² total area
 1 & 2 = 1094mm² 45% space factor
Internal dimensions
 Compartment 1 = 95 x 52mm
 Compartment 2 = 95 x 52mm

STERLING PROFILE 4 – no box
 1 = 1266mm² total area
 1 = 570mm² 45% space factor
 2 = 3858mm² total area
 2 = 1736mm² 45% space factor
 3 = 3858mm² total area
 3 = 1736mm² 45% space factor
With box in comp 2 or 3
 2 = 1376mm² total area
 2 = 619mm² 45% space factor
 3 = 1234mm² total area
 3 = 555mm² 45% space factor
Internal dimensions
 Compartment 1 = 39 x 45mm
 Compartment 2 = 86 x 46mm
 Compartment 3 = 86 x 46mm

XL202 – no box
 1 = 2824mm² total area
 1 = 1271mm² 45% space factor
 2 = 4771mm² total area
 2 = 2147mm² 45% space factor
 3 = 3531mm² total area
 3 = 1589mm² 45% space factor
With box in comp 2
 2 = 2504mm² total area
 2 = 1127mm² 45% space factor
Internal dimensions
 Compartment 1 = 64 x 62mm
 Compartment 2 = 84 x 62mm
 Compartment 3 = 64 x 62mm

XL212 – no box
 1 = 2824mm² total area
 1 = 1271mm² 45% space factor
 2 = 4771mm² total area
 2 = 2147mm² 45% space factor
 3 = 4732mm² total area
 3 = 2130mm² 45% space factor
 4 = 3531mm² total area
 4 = 1589mm² 45% space factor
With box in comps 2 or 3
 2 = 2511mm² total area
 2 = 1130mm² 45% space factor
 3 = 2466mm² total area
 3 = 1109mm² 45% space factor
Internal dimensions
 Compartment 1 = 61 x 61mm
 Compartment 2 = 87 x 61mm
 Compartment 3 = 87 x 61mm
 Compartment 4 = 61 x 61mm

Mono 10 and Mono Plus 20 trunking – PVC-U

Material

PVC-U is flame retardant and self-extinguishing. It is a 100% recyclable material.

Our PVC-U products are manufactured from an average of 80% recycled plastic, with some extruded products produced from 100% recycled material. The index at the back of the catalogue details the recycled content by individual product.

Positioning

- Mono 10
For dado application only.
- Mono Plus 20
If used for skirting applications, a clearance of 10mm is recommended above the floor covering to maintain IP4X rating.

Screening

Please contact our Technical Team on +44 (0)1424 856688.

Antimicrobial

For technical details of antimicrobial Mono Plus 20 Bio trunking, please refer to Laboratory and Healthcare section on page 293.

Dimensions

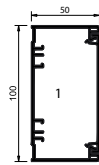

Mono 10 trunking – no box

Compartment 1 total area = 4141mm²

Internal dimensions

Compartment 1 = 96 x 46mm

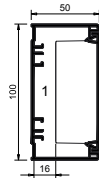

Mono 10 trunking – with box

Compartment 1 total area = 1874mm²

Internal dimensions

Compartment 1 = 96 x 46mm

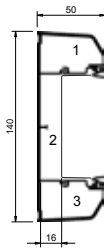

Mono Plus 20 trunking – with box

Compartment 1 total area = 1024mm²

Compartment 2 total area = 1185mm²

Compartment 3 total area = 1024mm²

Internal dimensions

Compartment 1 = 27 x 45mm

Compartment 2 = 77 x 46mm

Compartment 3 = 27 x 45mm

Cable capacities

- All calculations allow for a 45% space factor.

As there can be differences between data cable sizes, Marshall-Tufflex recommend that cable dimensions are confirmed with the manufacturing company.

Cable capacity chart	Compartment 1		Compartment 2		Compartment 3	
	No box	With box	No box	With box	No box	With box
PVC power cable 1.5mm² stranded copper						
Mono 10	216	98	–	–	–	–
Mono Plus 20	53	–	180	62	53	–
PVC power cable 2.5mm² stranded copper						
Mono 10	147	66	–	–	–	–
Mono Plus 20	36	–	123	42	36	–
PVC power cable 4.0mm² stranded copper						
Mono 10	112	50	–	–	–	–
Mono Plus 20	27	–	93	32	27	–
Data cable: Ø5.5mm						
Mono 10	78	35	–	–	–	–
Mono Plus 20	19	–	65	22	19	–
Data cable: Ø6.0mm						
Mono 10	65	29	–	–	–	–
Mono Plus 20	16	–	54	18	16	–
Data cable: Ø6.5mm						
Mono 10	56	25	–	–	–	–
Mono Plus 20	13	–	46	16	13	–
Data cable: Ø7.0mm						
Mono 10	48	21	–	–	–	–
Mono Plus 20	11	–	40	13	11	–
Data cable: Ø8.4mm						
Mono 10	33	15	–	–	–	–
Mono Plus 20	8	–	28	9	8	–



Compact trunking

Material

PVC-U is flame retardant and self-extinguishing. Our PVC-U products are manufactured from an average of 80% recycled plastic, with some extruded products produced from 100% recycled material. The index at the back of the catalogue details the recycled content by individual product.

Positioning

Compact 1, 2 and 3 are suitable for dado and skirting. If used for skirting applications, a clearance of 10mm is recommended above the floor covering to maintain IP4X rating.

If Compact 2 is installed close to desk/bench top – invert so small compartment is on bottom.

Screening

Special conductive spray coating can be applied to one compartment, the cover, accessory boxes and fittings, to screen data cables against EMI interference.

- **For data/voice circuits only:**

Warning: Owing to its relatively high surface resistance, CS coating SHOULD NOT be in contact with low voltage circuits as per the current version of BS 7671 wiring regulations. V.A.C. – 1000 V.A.C. unless additional measures are undertaken.

Antimicrobial

For technical details of antimicrobial Bio Compact trunking, please refer to Laboratory and Healthcare section on page 293.

Dimensions

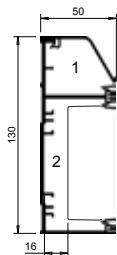

Compact 1 trunking – with box

Compartment 1 total area = 1280mm²
Compartment 2 total area = 1497mm²

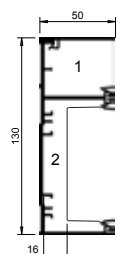

Compact 2 trunking – no box

Compartment 1 total area = 1534mm²
Compartment 2 total area = 3763mm²

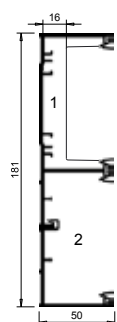

Compact 3 trunking – no box

Compartment 1 total area = 3763mm²
Compartment 2 total area = 3700mm²

Cable capacities

- All calculations allow for a 45% space factor.

As there can be differences between data cable sizes, Marshall-Tufflex recommend that cable dimensions are confirmed with the manufacturing company.

Cable capacity chart	Compartment 1		Compartment 2	
	No box	With box	No box	With box

PVC power cable 1.5mm² stranded copper

Compact 1	66	–	196	78
Compact 2	80	–	196	78
Compact 3	196	78	193	75

PVC power cable 2.5mm² stranded copper

Compact 1	45	–	134	53
Compact 2	53	–	134	53
Compact 3	134	53	132	75

PVC power cable 4.0mm² stranded copper

Compact 1	34	–	102	40
Compact 2	41	–	102	40
Compact 3	101	40	100	39

Data cable: Ø5.5mm

Compact 1	24	–	71	28
Compact 2	29	–	71	28
Compact 3	71	28	69	27

Data cable: Ø6.0mm

Compact 1	20	–	59	20
Compact 2	24	–	59	20
Compact 3	59	22	58	22

Data cable: Ø6.5mm

Compact 1	17	–	50	20
Compact 2	20	–	50	20
Compact 3	50	17	50	20

Data cable: Ø7.0mm

Compact 1	14	–	43	–
Compact 2	17	–	43	–
Compact 3	43	17	43	16

Data cable: Ø8.4mm

Compact 1	10	–	30	12
Compact 2	12	–	30	12
Compact 3	30	12	30	11

Twin165 trunking

Material

PVC-U is flame retardant and self-extinguishing. It is a 100% recyclable material.

Our PVC-U products are manufactured from an average of 80% recycled plastic, with some extruded products produced from 100% recycled material. The index at the back of the catalogue details the recycled content by individual product.

Positioning

If used for skirting applications, a clearance of 10mm is recommended above the floor covering to maintain IP4X rating.

Screening

Special conductive spray coating can be applied to one compartment, the cover, accessory boxes and fittings, to screen data cables against EMI interference.

- **For data/voice circuits only:**
Warning: Owing to its relatively high surface resistance, CS coating SHOULD NOT be in contact with low voltage circuits as per the current version of BS 7671 wiring regulations. 50 V.A.C. – 1000 V.A.C. unless additional measures are undertaken.
- Part M box assemblies with contrasting coloured faceplates are available to meet the requirements of DDA regulations for Visual Impairment.

Dimensions

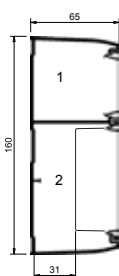

Twin165 trunking – no accessory box

Compartment 1 = 3272mm² total area
 Compartment 1 = 1472mm² 45% space factor
 Compartment 2 = 5404mm² total area
 Compartment 2 = 2431mm² 45% space factor

Twin165 trunking – with accessory box

Compartment 1 = 3272mm² total area
 Compartment 1 = 1472mm² 45% space factor
 Compartment 2 = 3100mm² total area
 Compartment 2 = 1395mm² 45% space factor

Cable capacities

- All calculations allow for a 45% space factor.

As there can be differences between data cable sizes, Marshall-Tufflex recommend that cable dimensions are confirmed with the manufacturing company.

Cable capacity chart	Compartment 1		Compartment 2	
	No box	With box	No box	With box
PVC power cable 1.5mm ² stranded copper	171	–	282	162
PVC power cable 2.5mm ² stranded copper	116	–	193	110
PVC power cable 4.0mm ² stranded copper	88	–	146	84
Data cable: Ø5.5mm	61	–	102	58
Data cable: Ø6.0mm	52	–	86	49
Data cable: Ø6.5mm	44	–	73	42
Data cable: Ø7.0mm	38	–	63	36
Data cable: Ø8.4mm	26	–	43	25

Sterling Profile trunking

Material

PVC-U is flame retardant and self-extinguishing. It is a 100% recyclable material.

Our PVC-U products are manufactured from an average of 80% recycled plastic, with some extruded products produced from 100% recycled material. The index at the back of the catalogue details the recycled content by individual product.

Positioning

If used for skirting applications, a clearance of 10mm is recommended above the floor covering to maintain IP4X rating.

Screening

Special conductive spray coating can be applied to one compartment, the cover, accessory boxes and fittings, to screen data cables against EMI interference.

- **For data/voice circuits only:**

Warning: Owing to its relatively high surface resistance, CS coating SHOULD NOT be in contact with low voltage circuits as per the current version of BS 7671 wiring regulations. 50 V.A.C. – 1000 V.A.C. unless additional measures are undertaken.

Antimicrobial

For technical details of antimicrobial Sterling Profile Bio trunking, please refer to Laboratory and Healthcare section on page 293.

Dimensions

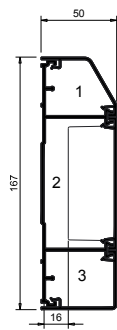

Sterling Profile 2 no box

- 1 = 1266mm² total area
- 1 = 570mm² 45% space factor
- 2 = 3858mm² total area
- 2 = 1736mm² 45% space factor
- 3 = 1542mm² total area
- 3 = 694mm² 45% space factor

With box in comp 2

- 2 = 1376mm² total area
- 2 = 619mm² 45% space factor

Note: The dimensions shown in this drawing can be used to work out dimensions for Sterling Profiles 1 and 3.

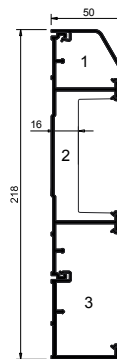

Sterling Profile 4 no box

- 1 = 1266mm² total area
- 1 = 570mm² 45% space factor
- 2 = 3858mm² total area
- 2 = 1736mm² 45% space factor
- 3 = 3716mm² total area
- 3 = 1672mm² 45% space factor

With box in comp 2 or 3

- 2 = 1376mm² total area
- 2 = 619mm² 45% space factor
- 3 = 1234mm² total area
- 3 = 555mm² 45% space factor

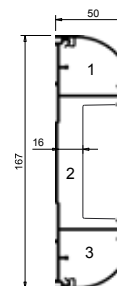

Sterling Curve Profile 1 – no box

- 1 & 3 = 1170mm² total area
- 1 & 3 = 527mm² 45% space factor
- 2 = 3858mm² total area
- 2 = 1736mm² 45% space factor

With box in comp 2

- 2 = 1376mm² total area
- 2 = 619mm² 45% total area

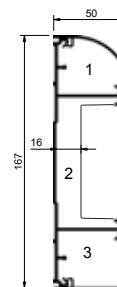

Sterling Curve Profile 2 – no box

- 1 = 1170mm² total area
- 1 = 527mm² 45% space factor
- 2 = 3858mm² total area
- 2 = 1736mm² 45% space factor
- 3 = 1542mm² total area
- 3 = 694mm² 45% space factor

With box in comp 2

- 2 = 1376mm² total area
- 2 = 619mm² 45% space factor

Sterling Profile

Cable capacities

- All calculations allow for a 45% space factor.

As there can be differences between cable sizes, Marshall-Tufflex recommend that cable dimensions are confirmed with the manufacturing company.

Cable capacity chart	Compartment 1		Compartment 2		Compartment 3	
	No box	With box	No box	With box	No box	With box
PVC power cable 1.5mm² stranded copper						
Sterling Profile 1	66	-	201	71	66	-
Sterling Profile 2	66	-	201	71	80	-
Sterling Profile 3	80	-	201	71	80	-
Sterling Profile 4	66	-	201	71	194	69
Sterling Curve Profile 1	61	-	201	71	61	-
Sterling Curve Profile 2	61	-	201	71	80	-
PVC power cable 2.5mm² stranded copper						
Sterling Profile 1	45	-	137	49	45	-
Sterling Profile 2	45	-	137	49	55	-
Sterling Profile 3	55	-	137	49	55	-
Sterling Profile 4	45	-	137	49	132	47
Sterling Curve Profile 1	41	-	137	49	41	-
Sterling Curve Profile 2	41	-	137	49	55	-
PVC power cable 4.0mm² stranded copper						
Sterling Profile 1	34	-	104	37	34	-
Sterling Profile 2	34	-	104	37	41	-
Sterling Profile 3	41	-	104	37	41	-
Sterling Profile 4	34	-	104	37	100	33
Sterling Curve Profile 1	31	-	104	37	31	-
Sterling Curve Profile 2	31	-	104	37	41	-
Data cable: Ø5.5mm²						
Sterling Profile 1	23	-	73	26	23	-
Sterling Profile 2	23	-	73	26	29	-
Sterling Profile 3	29	-	73	26	29	-
Sterling Profile 4	23	-	73	26	70	23
Sterling Curve Profile 1	22	-	73	26	23	-
Sterling Curve Profile 2	22	-	73	26	29	-
Data cable: Ø6.0mm²						
Sterling Profile 1	20	-	61	21	20	-
Sterling Profile 2	20	-	61	21	24	-
Sterling Profile 3	24	-	61	21	24	-
Sterling Profile 4	20	-	61	21	59	20
Sterling Curve Profile 1	18	-	61	21	18	-
Sterling Curve Profile 2	18	-	61	21	24	-
Data cable: Ø6.5mm²						
Sterling Profile 1	17	-	52	18	17	-
Sterling Profile 2	17	-	52	18	20	-
Sterling Profile 3	20	-	52	18	20	-
Sterling Profile 4	17	-	52	18	50	17
Sterling Curve Profile 1	15	-	52	18	15	-
Sterling Curve Profile 2	15	-	52	18	20	-
Data cable: Ø7.0mm²						
Sterling Profile 1	14	-	45	16	14	-
Sterling Profile 2	14	-	45	16	18	-
Sterling Profile 3	18	-	45	16	18	-
Sterling Profile 4	14	-	45	16	43	14
Sterling Curve Profile 1	13	-	45	16	13	-
Sterling Curve Profile 2	13	-	45	16	18	-
Data cable: Ø8.4mm²						
Sterling Profile 1	10	-	31	11	10	-
Sterling Profile 2	10	-	31	11	12	-
Sterling Profile 3	12	-	31	11	12	-
Sterling Profile 4	10	-	31	11	30	10
Sterling Curve Profile 1	9	-	31	11	9	-
Sterling Curve Profile 2	9	-	31	11	12	-

Odyssey trunking

Material

Odyssey accessory boxes and fittings are flame retardant ABS which is 100% recyclable.

Our PVC-U products are manufactured from an average of 80% recycled plastic, with some extruded products produced from 100% recycled material. The index at the back of the catalogue details the recycled content by individual product.

Positioning

For dado, horizontal or vertical installation.

Screening

Special conductive spray coating can be applied to one compartment, the cover, accessory boxes and fittings, to screen data cables against EMI interference.

Please contact our Technical Team on +44 (0)1424 856688.

- **For data/voice circuits only:**

Warning: Owing to its relatively high surface resistance, CS coating SHOULD NOT be in contact with low voltage circuits as per the current version of BS 7671 wiring regulations. 50 V.A.C. – 1000 V.A.C. unless additional measures are undertaken.

Antimicrobial

For technical details of antimicrobial Odyssey Bio trunking, please refer to Laboratory and Healthcare section on page 293.

Dimensions

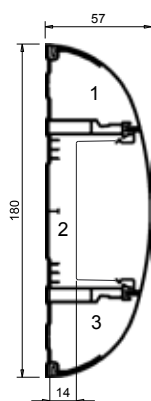

Odyssey trunking – with box

Compartment 1 & 3 total area = 1278mm²

Compartment 2 total area = 859mm²

Odyssey trunking – no box

Compartment 2 total area = 3972mm²

Cable capacities

- All calculations allow for a 45% space factor.

As there can be differences between data cable sizes, Marshall-Tufflex recommend that cable dimensions are confirmed with the manufacturing company.

Cable capacity chart	Compartment 1		Compartment 2		Compartment 3	
	No box	With box	No box	With box	No box	With box
PVC power cable 1.5mm ² stranded copper	65	–	210	64	65	–
PVC power cable 2.5mm ² stranded copper	44	–	143	43	44	–
PVC power cable 4.0mm ² stranded copper	34	–	109	33	34	–
Data cable: Ø5.5mm	23	–	76	23	23	–
Data cable: Ø6.0mm	19	–	63	19	19	–
Data cable: Ø6.5mm	17	–	54	16	17	–
Data cable: Ø7.0mm	14	–	47	14	14	–
Data cable: Ø8.4mm	10	–	32	10	10	–

Twin Plus trunking

Material

PVC-U is flame retardant and self-extinguishing. It is a 100% recyclable material.

Our PVC-U products are manufactured from an average of 80% recycled plastic, with some extruded products produced from 100% recycled material. The index at the back of the catalogue details the recycled content by individual product.

Positioning

If used for skirting applications, a clearance of 10mm is recommended above the floor covering to maintain IP4X rating.

Screening

Special conductive spray coating can be applied to one compartment, the cover, accessory boxes and fittings, to screen data cables against EMI interference.

- **For data/voice circuits only:**

Warning: Owing to its relatively high surface resistance, CS coating SHOULD NOT be in contact with low voltage circuits as per the current version of BS 7671 wiring regulations. 50 V.A.C. – 1000 V.A.C. unless additional measures are undertaken.

Antimicrobial

For technical details of antimicrobial Twin Plus Bio trunking, please refer to Laboratory and Healthcare section on page 293.

Dimensions

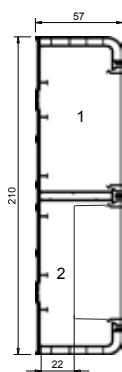

Twin Plus trunking – with accessory box

- 1 = 2431mm² total area
- 1 = 1094mm² 45% space factor
- 2 = 2431mm² total area
- 2 = 1094mm² 45% space factor

Twin Plus trunking – no accessory box

- 1 = 4755mm² total area
- 1 = 2139mm² 45% space factor
- 2 = 4755mm² total area
- 2 = 2139mm² 45% space factor

Cable capacities

- All calculations allow for a 45% space factor.

As there can be differences between data cable sizes, Marshall-Tufflex recommend that cable dimensions are confirmed with the manufacturing company.

Cable capacity chart	Compartment 1		Compartment 2	
	No box	With box	No box	With box
PVC power cable 1.5mm ² stranded copper	248	127	248	127
PVC power cable 2.5mm ² stranded copper	169	86	169	86
PVC power cable 4.0mm ² stranded copper	128	65	128	65
Data cable: Ø5.5mm	89	46	89	46
Data cable: Ø6.0mm	75	38	75	38
Data cable: Ø6.5mm	64	32	64	32
Data cable: Ø7.0mm	55	28	55	28
Data cable: Ø8.4mm	38	19	38	19

XL trunking

Material

PVC-U is flame retardant and self-extinguishing. It is a 100% recyclable material.

Our PVC-U products are manufactured from an average of 80% recycled plastic, with some extruded products produced from 100% recycled material. The index at the back of the catalogue details the recycled content by individual product.

Positioning

If used for skirting applications, a clearance of 10mm is recommended above the floor covering to maintain IP4X rating.

Screening

Special conductive spray coating can be applied to one compartment, the cover, accessory boxes and fittings, to screen data cables against EMI interference.

- **For data/voice circuits only:**

Warning: Owing to its relatively high surface resistance, CS coating SHOULD NOT be in contact with low voltage circuits As per the current version of BS 7671 wiring regulations. 50 V.A.C. – 1000 V.A.C. unless additional measures are undertaken.

Antimicrobial

For technical details of antimicrobial XL Bio trunking, please refer to Laboratory and Healthcare section on page 293.

Dimensions

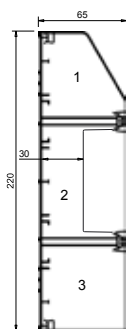

XL202 Trunking - with box

- 1 = 2824mm² total area
- 1 = 1270mm² 45% space factor
- 2 = 2504mm² total area
- 2 = 1126mm² 45% space factor
- 3 = 3531mm² total area
- 3 = 1589mm² 45% space factor

XL202 Trunking - no box

- 2 = 4771mm² total area
- 2 = 2147mm² 45% space factor

Note: The dimensions shown in this drawing can be used to work out dimensions for XL201.

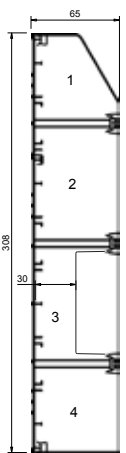

XL212 Trunking - no box

- 1 = 2824mm² total area
- 1 = 1270mm² 45% space factor
- 2 = 4771mm² total area
- 2 = 2147mm² 45% space factor
- 3 = 4732mm² total area
- 3 = 2129mm² 45% space factor
- 4 = 3531mm² total area
- 4 = 1589mm² 45% space factor

XL212 Trunking - with box in comp 2 or 3

- 2 = 2511mm² total area
- 2 = 1130mm² 45% space factor
- 3 = 2466mm² total area
- 3 = 1109mm² 45% space factor

Note: The dimensions shown in this drawing can be used to work out dimensions for XL211.

XL trunking – continued

Cable capacities

- All calculations allow for a 45% space factor.

As there can be differences between data cable sizes, Marshall-Tufflex recommend that cable dimensions are confirmed with the manufacturing company.

Cable capacity chart	Compartment 1		Compartment 2		Compartment 3		Compartment 4
	No box	With box	No box	With box	No box	With box	No box
PVC power cable 1.5mm² stranded copper							
XL201	147	–	249	131	147	–	–
XL202	147	–	249	131	184	–	–
XL211	147	–	249	131	247	124	147
XL212	147	–	249	131	247	124	184
PVC power cable 2.5mm² stranded copper							
XL201	100	–	170	89	100	–	–
XL202	100	–	170	89	126	–	–
XL211	100	–	170	89	168	88	100
XL212	100	–	170	89	168	88	126
PVC power cable 4.0mm² stranded copper							
XL201	76	–	129	67	76	–	–
XL202	76	–	129	67	95	–	–
XL211	76	–	129	65	128	66	76
XL212	76	–	129	65	128	66	95
Data cable: Ø5.5mm UTP & STP							
XL201	53	–	90	47	53	–	–
XL202	53	–	90	47	66	–	–
XL211	53	–	90	45	89	46	53
XL212	53	–	90	45	89	46	66
Data cable: Ø6.0mm UTP & STP							
XL201	44	–	75	39	44	–	–
XL202	44	–	75	39	56	–	–
XL211	44	–	75	38	75	37	44
XL212	44	–	75	38	75	37	56
Data cable: Ø6.5mm UTP & STP							
XL201	38	–	64	33	38	–	–
XL202	38	–	64	33	47	–	–
XL211	38	–	64	32	64	33	38
XL212	38	–	64	32	64	33	47
Data cable: Ø7.0mm UTP & STP							
XL201	33	–	55	29	33	–	–
XL202	33	–	55	29	41	–	–
XL211	33	–	55	28	55	28	33
XL212	33	–	55	28	55	28	41
Data cable: Ø8.4mm UTP & STP							
XL201	22	–	38	20	22	–	–
XL202	22	–	38	20	28	–	–
XL211	22	–	38	19	38	20	22
XL212	22	–	38	19	38	20	28

Mini trunking

Material

PVC-U is flame retardant and self-extinguishing. It is a 100% recyclable material.

Our PVC-U products are manufactured from an average of 80% recycled plastic, with some extruded products produced from 100% recycled material. The index at the back of the catalogue details the recycled content by individual product.

Positioning

As feeder trunking.

Cable capacities

- All calculations allow for a 45% space factor.
- Divide cable factor (1st table) into capacity (2nd table) to ascertain number of cables.

As there can be differences between data cable sizes, Marshall-Tufflex recommend that cable dimensions are confirmed with the manufacturing company.

Conductor type	Size	Cable factor
Stranded PVC power	1.5mm ²	8.6
Stranded PVC power	2.5mm ²	12.6
Stranded PVC power	4.0mm ²	16.6
*Data cable	Ø5.5mm	23.8
*Data cable	Ø6.0mm	28.3
*Data cable	Ø6.5mm	33.2
*Data cable	Ø7.0mm	38.5
*Data cable	Ø8.4mm	55.4

Mini trunking	Size mm	45% capacity
MMT00	10 x 8	18.5mm ²
MMT0	16 x 10	42mm ²
MMT1	16 x 16	77.2mm ²
MMT2	25 x 16	119.7mm ²
MMT3	38 x 16	193mm ²
MMT4	38 x 25	342mm ²
MMT5	50 x 25	449mm ²
MMT6	38 x 38	501mm ²

Maxi and Sceptre trunking

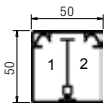

Maxi MTRS50

Total = 1979mm² total area
 Total = 890mm² 45% space factor
 1 & 2 = 911mm² total area
 1 & 2 = 410mm² 45% space factor

Internal dimensions

Compartment 1 = 46 x 46mm

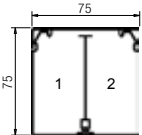

Maxi MTRS75

Total = 4709mm² total area
 Total = 2119mm² 45% space factor
 1 & 2 = 2196mm² total area
 1 & 2 = 988mm² 45% space factor

Internal dimensions

Compartment 1 = 71 x 71mm

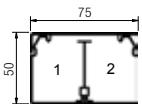

Maxi MTRS75/50

Total = 3032mm² total area
 Total = 1365mm² 45% space factor
 1 & 2 = 1347mm² total area
 1 & 2 = 606mm² 45% space factor

Internal dimensions

Compartment 1 = 71 x 46mm

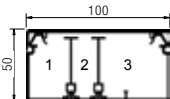

Maxi MTRS100/50

Total = 4040mm² total area
 Total = 1818mm² 45% space factor
 1 = 1056mm² total area
 1 = 475mm² 45% space factor
 2 = 660mm² total area
 2 = 297mm² 45% space factor
 3 = 1829mm² total area
 3 = 823mm² 45% space factor

Internal dimensions

Compartment 1 = 94 x 46mm

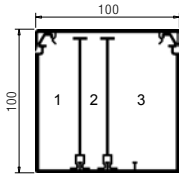

Maxi MTRS100

Total = 8733mm² total area
 Total = 3930mm² 45% space factor
 1 = 2375mm² total area
 1 = 1069mm² 45% space factor
 2 = 1464mm² total area
 2 = 659mm² 45% space factor
 3 = 4075mm² total area
 3 = 1834mm² 45% space factor

Internal dimensions

Compartment 1 = 94 x 94mm

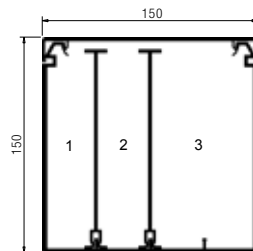

Maxi MTRS150

Total = 20193mm² total area
 Total = 9087mm² 45% space factor
 1 = 4406mm² total area
 1 = 1983mm² 45% space factor
 2 = 4728mm² total area
 2 = 2128mm² 45% space factor
 3 = 9482mm² total area
 3 = 4267mm² 45% space factor

Internal dimensions

Compartment 1 = 143 x 144mm

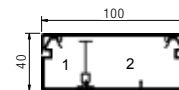

Sceptre DTR1

Total = 3168mm² total area
 Total = 1426mm² 45% space factor
 1 = 816mm² total area
 1 = 367mm² 45% space factor
 2 = 2002mm² total area
 2 = 901mm² 45% space factor

Conductor type	Size	Cable factor
Stranded PVC power	1.5mm ²	8.6
Stranded PVC power	2.5mm ²	12.6
Stranded PVC power	4.0mm ²	16.6
*Data cable	Ø5.5mm	23.8
*Data cable	Ø6.0mm	28.3
*Data cable	Ø6.5mm	33.2
*Data cable	Ø7.0mm	38.5
*Data cable	Ø8.4mm	55.4

For Data cable information, please see page 242

To determine cable capacity, select the size of the cable required and its corresponding cable factor from the table. Divide the compartment area figure (with or without 45% space factor) with the cable factor figure to achieve cable capacity.

Note: When 30mm deep accessory boxes are installed in MTRS100 and MTRS100/50, reduce the area by 2600mm².

Material

PVC-U is flame retardant and self-extinguishing. It is a 100% recyclable material.

Positioning

Feeder or distribution trunking.



Maxi and Sceptre trunking – continued

Maxi trunking Cable capacity chart	Total	Compartment 1	Compartment 2	Compartment 3
		With box	No box	With box
PVC power cable 1.5mm² stranded copper				
MTRS50	103	47	47	-
MTRS75	246	114	114	-
MTRS75/50	158	70	70	-
MTRS100/50	211	55	34	95
MTRS100	456	124	76	213
MTRS150	1056	230	247	496
PVC power cable 2.5mm² stranded copper				
MTRS50	70	32	32	-
MTRS75	168	78	78	-
MTRS75/50	108	48	48	-
MTRS100/50	144	37	23	65
MTRS100	311	84	52	145
MTRS150	721	157	168	338
PVC power cable 4.0mm² stranded copper				
MTRS50	53	24	24	-
MTRS75	127	59	59	-
MTRS75/50	82	36	36	-
MTRS100/50	109	28	17	49
MTRS100	236	64	39	110
MTRS150	547	119	128	257
Data cable: Ø5.5mm				
MTRS50	37	17	17	-
MTRS75	89	41	41	-
MTRS75/50	57	25	25	-
MTRS100/50	74	20	12	34
MTRS100	165	44	27	77
MTRS150	381	83	89	179
Data cable: Ø6.0mm				
MTRS50	31	14	14	-
MTRS75	74	34	34	-
MTRS75/50	48	21	21	-
MTRS100/50	64	16	10	29
MTRS100	138	37	23	64
MTRS150	321	70	75	150
Data cable: Ø6.5mm				
MTRS50	26	12	12	-
MTRS75	63	19	29	-
MTRS75/50	41	18	18	-
MTRS100/50	54	14	8	24
MTRS100	118	32	19	55
MTRS150	273	59	64	128
Data cable: Ø7.0mm				
MTRS50	23	10	10	-
MTRS75	55	25	25	-
MTRS75/50	35	15	15	-
MTRS100/50	47	12	7	21
MTRS100	102	27	17	47
MTRS150	236	51	55	110
Data cable: Ø8.4mm				
MTRS50	16	7	7	-
MTRS75	38	17	17	-
MTRS75/50	24	10	10	-
MTRS100/50	32	8	5	14
MTRS100	70	19	11	33
MTRS150	164	35	38	76

Cable capacities

- All calculations allow for a 45% space factor.

As there can be differences between data cable sizes, Marshall-Tufflex recommend that cable dimensions are confirmed with the manufacturing company.

Sceptre trunking Cable capacity chart	Total	Compartment 1	Compartment 2
		No box	No box
PVC power cable 1.5mm² stranded copper			
DTR1	165	42	104
PVC power cable 2.5mm² stranded copper			
DTR1	113	29	71
PVC power cable 4.0mm² stranded copper			
DTR1	85	22	54
Data cable: Ø5.5mm			
DTR1	59	15	37
Data cable: Ø6.0mm			
DTR1	50	12	31
Data cable: Ø6.5mm			
DTR1	42	11	27
Data cable: Ø7.0mm			
DTR1	37	9	23
Data cable: Ø8.4mm			
DTR1	25	6	16

Cornice trunking

Material

PVC-U is flame retardant and self-extinguishing. It is a 100% recyclable material.

Our PVC-U products are manufactured from an average of 80% recycled plastic, with some extruded products produced from 100% recycled material. The index at the back of the catalogue details the recycled content by individual product.

Positioning

For surface wiring around ceilings.

Dimensions

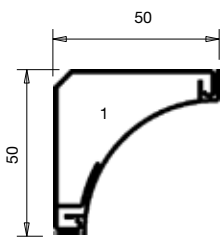

1 = 873mm² total area
 1 = 393mm² 45% space factor

Cable capacities

- All calculations allow for a 45% space factor.

As there can be differences between data cable sizes, Marshall-Tufflex recommend that cable dimensions are confirmed with the manufacturing company.

Cable capacity chart	Cable factor	Compartment 1
PVC power cable 1.5mm ² stranded copper	8.6	45
PVC power cable 2.5mm ² stranded copper	12.6	31
PVC power cable 4.0mm ² stranded copper	16.6	23
Data cable: Ø5.5mm	23.8	16
Data cable: Ø6.0mm	28.3	13
Data cable: Ø6.5mm	33.2	11
Data cable: Ø7.0mm	38.5	10
Data cable: Ø8.4mm	55.4	7

Sovereign Plus trunking

Material

PVC-U is flame retardant and self-extinguishing. It is a 100% recyclable material.

Our PVC-U products are manufactured from an average of 80% recycled plastic, with some extruded products produced from 100% recycled material. The index at the back of the catalogue details the recycled content by individual product.

Positioning

Suitable for skirting and architrave. If used for skirting applications, a clearance of 10mm is recommended above the floor covering to maintain IP4X rating.

Bend radius control

Not available.

Screening

Not available.

Offset dimensions

The minimum set that can be accommodated in the same plane (from internal to external bend), is shown below:

Dimensions

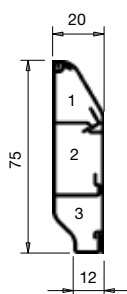

Sovereign Plus skirting

- 1 = 238mm² total area
1 = 107mm² 45% space factor
- 2 = 416mm² total area
2 = 187mm² 45% space factor
- 3 = 261mm² total area
3 = 117mm² 45% space factor

Cable capacities

- All calculations allow for a 45% space factor.

As there can be differences between data cable sizes, Marshall-Tufflex recommend that cable dimensions are confirmed with the manufacturing company.

Cable capacity chart	Compartment 1	Compartment 2	Compartment 3
PVC power cable 1.5mm² stranded copper			
Sovereign Plus	12	21	13
PVC power cable 2.5mm² stranded copper			
Sovereign Plus	8	14	9
PVC power cable 4.0mm² stranded copper			
Sovereign Plus	6	11	7
Data cable: Ø5.5mm			
Sovereign Plus	4	7	4
Data cable: Ø6.0mm			
Sovereign Plus	3	6	4
Data cable: Ø6.5mm			
Sovereign Plus	3	5	3
Data cable: Ø7.0mm			
Sovereign Plus	2	4	3
Data cable: Ø8.4mm			
Sovereign Plus	1	3	2

Bench trunking

Material

PVC-U is flame retardant and self-extinguishing. It is a 100% recyclable material.

Our PVC-U products are manufactured from an average of 80% recycled plastic, with some extruded products produced from 100% recycled material. The index at the back of the catalogue details the recycled content by individual product.

Positioning

If used for skirting applications, a clearance of 10mm is recommended above the floor covering to maintain IP4X rating.

Bench and desk installations: a single run can be fitted to rear of furniture or, if run down centre line, two units can be joined back to back presenting accessories on both sides.

Antimicrobial

For technical details of antimicrobial Bio Bench trunking, please refer to Laboratory and Healthcare section on page 293.

Dimensions

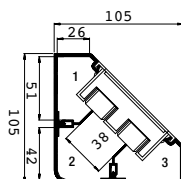

Bench trunking – with box

- 1 = 1285mm² total area
- 1 = 578mm² 45% space factor
- 2 = 2128mm² total area
- 2 = 957mm² 45% space factor
- 3 = 1285mm² total area
- 3 = 578mm² 45% space factor

Bench trunking – no box

- 1 = 1782mm² total area
- 1 = 802mm² 45% space factor
- 2 = 3282mm² total area
- 2 = 1477mm² 45% space factor
- 3 = 1782mm² total area
- 3 = 802mm² 45% space factor

Cable capacities

- All calculations allow for a 45% space factor.

As there can be differences between data cable sizes, Marshall-Tufflex recommend that cable dimensions are confirmed with the manufacturing company.

Cable capacity chart	Compartment 1		Compartment 2		Compartment 3	
	No box	With box	No box	With box	No box	With box
PVC power cable 1.5mm ² stranded copper	93	67	171	111	93	67
PVC power cable 2.5mm ² stranded copper	63	45	117	76	63	45
PVC power cable 4.0mm ² stranded copper	48	34	88	57	48	34
Data cable: Ø5.5mm	33	24	62	40	33	24
Data cable: Ø6.0mm	28	20	52	33	28	20
*Data cable: Ø6.5mm	24	17	44	28	24	17
*Data cable: Ø7.0mm	20	15	38	24	20	15
*Data cable: Ø8.4mm	14	10	26	17	14	10

*Only for straight runs. If bends are required please contact the Technical Team on +44 (0)1424 856688.



Accessory boxes and enclosures

Square and rectangular dry lining accessory boxes

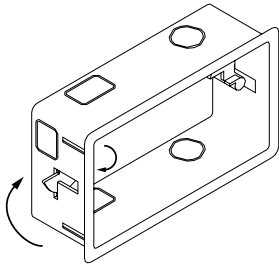

Circular dry lining accessory boxes

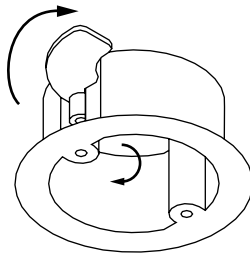

Moulded enclosures Adaptable boxes

Adaptable boxes as supplied, have a degree of IP66 protection. Any openings that are drilled or cut into the box body and are not sealed with appropriate IP66 components, or a failure to use the silicon rubber seal fitted will negate the IP66 rating.

Lug Colour	Adjustment
Grey	1 – 9mm
White	6 – 14mm
Green	18 – 25mm
Black	9 – 26mm

Lug Colour	Type
White	Dual entry box

Note: Ceiling mounted circular boxes can support 3kg centrally at 60°C maximum subject to ceiling construction.

Cut out dimensions

Box type	Cut out size
1 gang	73 x 73mm
2 gang	135 x 73mm
Dual gang	157 x 73mm

	Dual entry
Board thickness	9-32mm
Entry	Ø20mm x2 off KO
Aperture size	Ø70.0mm
Internal depth	34mm
Fixing centres	M4.0 x 50.8mm M3.5 x 60.3mm

Screening

- Boxes available with copper spray screening to protect data outlets from electromagnetic interference.

Part M boxes and box assemblies

- Comply with the requirements of Part M (DDA)
- Odyssey coloured boxes (DD1510 and DD1520) with coloured flanges to contrast with trunking cover colour.
- ESPM box assemblies with contrasting coloured flush accessory box frames. For colour varieties please view the perimeter trunking pages.

Adjustable accessory box depth by product range

	Maximum adjustment range	Page Reference
PowerPoles and PowerPosts		
Series 1 and 2	32 - 40mm	186
PVC-U Perimeter Trunking		
Mono 10	32 - 40mm	55
Mono Plus 20	32 - 40mm	57
Compact 1	32 - 40mm	59
Compact 2	32 - 40mm	61
Compact 3	32 - 40mm	63
Twin165	32 - 47mm	66
Sterling Profile 1 - 3	32 - 45mm	68
Sterling Profile 4*	32 - 45mm	74
Sterling Curve	32 - 45mm	77
Odyssey	32 - 40mm	84
Twin Plus	32 - 47mm	86
XL Trunking 201 - 202	32 - 47mm	89
XL Trunking 211 - 212	32 - 47mm	93
PVC-U Trunking		
Bench Trunking	32 - 47mm	115
Aluminium Trunking		
Bench Trunking	32 - 47mm	152
Elegance 110	32 - 40mm	154
Sterling Profile 1 - 3	32 - 40mm	156
Sterling Curve Profile 1 & 2	32 - 40mm	160
Elegance 170	32 - 40mm	165
Twin Plus	32 - 47mm	167
XL Trunking 301 - 302	32 - 47mm	170

*The EAB1/2 can be adjusted to 45mm in the main compartment only. Where the EBE1 Base Extension is used the maximum adjustment achievable is 40mm

PVC-U Conduit

Material

PVC-U is flame retardant and self-extinguishing. It is a 100% recyclable material.

Our PVC-U products are manufactured from an average of 80% recycled plastic, with some extruded products produced from 100% recycled material. The index at the back of the catalogue details the recycled content by individual product.

Installation

The properties of PVC-U make it an all insulated system and the use of a separate earth cable is essential.

Joint sealant

- Solvent cement MSC is a slow acting solvent cement especially formulated for watertight conduit fittings.

In accordance with COSHH Regulations, details of our solvents are entered in The National Poison Centre computer records. Health & Safety data sheets are available from our Technical Team or on the technical page of the Marshall-Tufflex website: www.marshall-tufflex.com

MT Supertube

General information

MT Supertube provides LSOH polyethylene-coated aluminium cable protection for installation where halogen free products are a requirement.

Material

Conduit: A seamless aluminium tube sandwiched between two layers of extruded LSOH polyethylene.

Fittings: LSOH polycarbonate or cast metal with paint finish. (black or white).

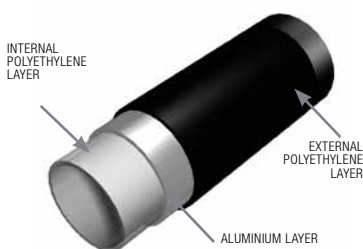

Shielding effectiveness

Shielding effectiveness (attenuation in dB) measures the ratio between the external environment field strength and the field strength after passing through any material. This is recorded in a logarithmic scale.

Shielding effectiveness	
Attenuation in dB	Field strength reduction
6	2
20	10
40	100
60	1000
80	10000

MT Supertube multi layer conduit systems absorbs and reflect emitted radiation from sources of interference, where an attenuation of 80dB would reduce the resultant field within MT Supertube by a factor of 10,000. (See tables.)

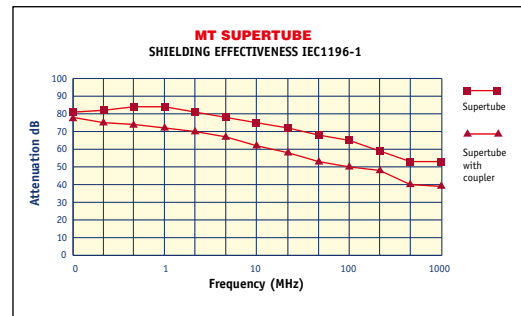

The graphs above show that the shielding effectiveness of MT Supertube is highly effective throughout the entire frequency range and will provide protection from interference for data, telecoms and signal cables.

Mechanical		MT Supertube & MT Supertube FR	MT Supertube & MT Supertube FR
Tube reference		22010/22003	22505/22503
Outside diameter	(mm) OD	20	25
Internal diameter	(mm) ID	15.5	20
Wall thickness	(mm) W	2.25	2.5
Minimum bend radius	(8 x dia)	160	200
Weight per metre	(g)	145	184
Lengths	(m)	100/3	50/3
Suspension distance (maximum)	Horizontal (mm)	1000	
	Vertical (mm)	1200	

Mechanical	MT Supertube	MT Supertube FR
Electrical breakdown resistance	20,000 V	20,000 V
Temperature range °C	-45 +120	-45 +289
Thermal expansion coefficient	2.0 x 10-6mm/m/K	2.0 x 10-6mm/m/K
Thermal conductivity	0.45 W (mK)	0.45 W (mK)
Earth bonding/continuity test results	<0.05 Ω	<0.05 Ω
Standards	EN 61386-21	EN 61386-21
	IEC 601196-1	IEC 601196-1

WARNING NAIL PENETRATION: MT Supertube FR Plus complies with the current requirements for BS 7671, BS 8436 and BS EN 61386. Screening to ENIEC 1196-1.

MT Supertube FR Plus performance

Fire Performance				
Oxygen Index	BS EN ISO 4589-2	46.5%		
Flammability Temperature (Temperature Index)	BS EN ISO 4589-3	289°C		
Elemental composition	Lassaigne Sodium	Nitrogen	Negative	
		Fusion	Chloride	Negative
			Bromide	Negative
			Fluoride	Negative
			Sulphur	Negative
Smoke Density	Low Smoke			

Conduit Performance (BS EN 50086.1.2)	
Cold temperature impact test	Heavy gauge performance
Compression	Low compression
Resistance to flame propagation	Pass

TECHNICAL INFORMATION



Callmaster fire and safety systems

Material

PVC-U is flame retardant and self-extinguishing. It is a 100% recyclable material. It complies with the requirements of BS 4761 Parts 6 and 7 and BS 4678. The Callmaster system is designed to comply with IET Wiring Regulations BS 7671:2018.

Boxes

Dimensional data for square boxes

- Overall: 87 x 87mm
- Depth: 38mm external; 35mm internal
- Fixing centres: 60.3mm
- Pot size: Ø15mm

Dimensional data for circular boxes

- Overall diameter: 123mm excluding adaptors
- Depth: 28mm external; 24mm internal
- Dual fixing centre: 50.8 and 60.3mm
- Pot size: Ø15mm

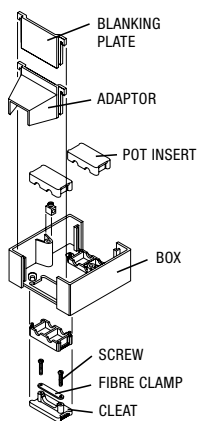

Mini trunking additional adaptors

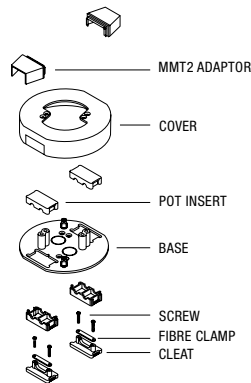

Intumescent (fire barrier) pads

Marshall-Tufflex dry lining boxes are available with intumescent (fire barrier) pads to comply with the current version of the BS 7671 Wiring Regulations and Document B of the UK Building Regulations.



Firefly Fire Clips

Standards

Compliant with the general principles of BS 5839-1:2013 Section 26.2d when independently tested.

Dimensions

Conduit Firefly Clips

FCCR20

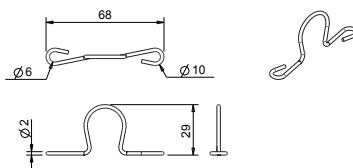

FCCR25

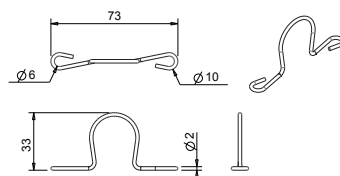

Mini Trunking Firefly Clips

FCMMT2

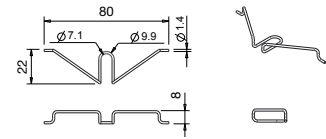

FCMMT3

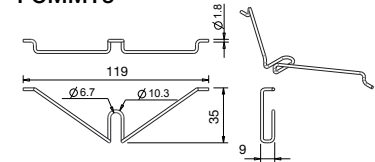

FCMMT4

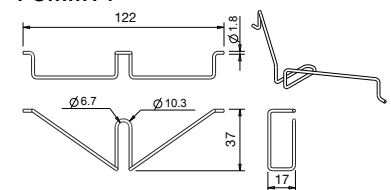

FCMMT5

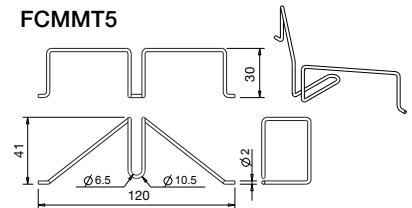

FCMMT6

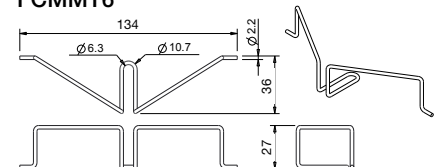

FCXMMT2

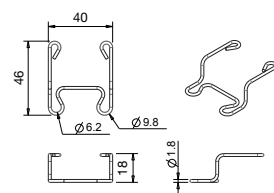

FCXMMT4

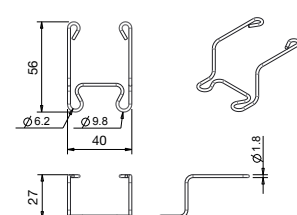

Maxi Trunking Firefly Clips

FCMTRS50

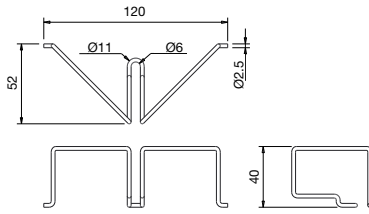

FCMTRS75-50

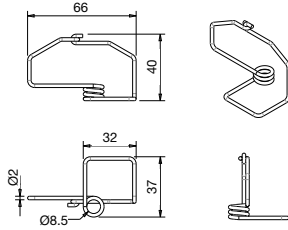

FCMTRS75

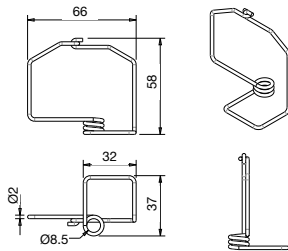

FCMTRS100-50

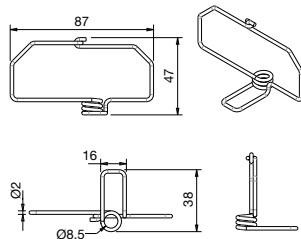

FCMTRS100

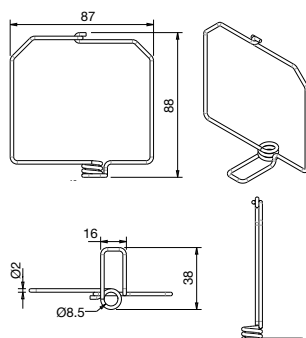

Mono 10 Firefly Clips

FCM10C (centre compartment)

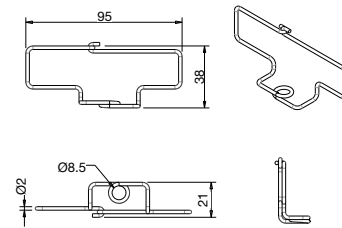

FCM20C (centre compartment)

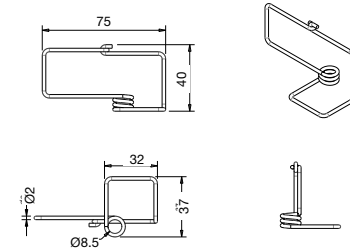

Sterling Firefly Clips

FCSPC (centre compartment)

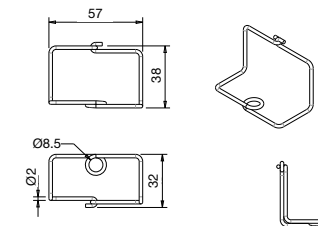

FCSPS (square compartment)

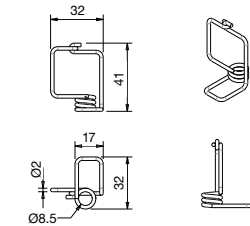

FCSPAC (angle/curve compartment)

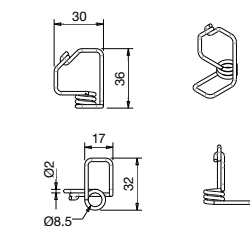

Odyssey Firefly Clips

FCOC (centre compartment)

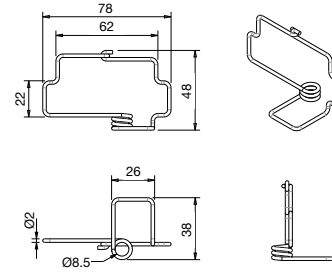

FCOO (outer compartment)

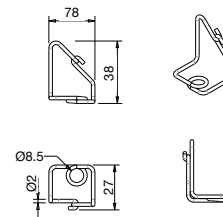

Twin Plus Firefly Clips

FCTP

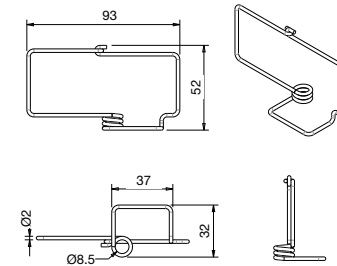

Twin165 Firefly Clips

FCT165L (large compartment)

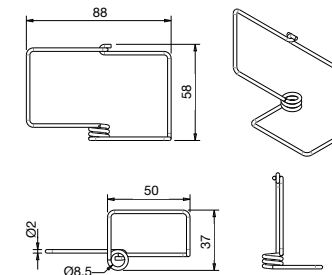

FCT165S (small compartment)

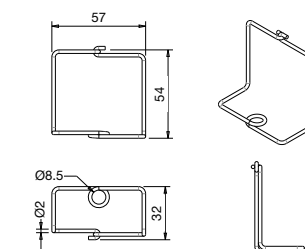

Self Tapping Masonry Screw 4.7mm x 37mm and washers

We recommend that self-tapping masonry screws are used when installing Firefly fire clips.



- DESIGNED FOR** Fixing of Firefly clips to trunking, timber track and general components into concrete and masonry.
- HEAD STYLE** Countersunk
- DRIVE BIT** Phillips 2
- DRILL POINT** Nail point
- COATING** 500hr Evoshield®
- SHANK MATERIAL** Carbon steel
- MATERIAL GRADE** AISI C1022

Size	Fixture Thickness mm	Minimum Drill Depth mm	Minimum Embedment Depth mm	Pilot Hole mm
4.7 x 37mm	5.0 – 20.0	35.0	25.0	4.35

Characteristic pull out loads				
Embedment depth mm	35N /mm ² concrete kN	Common masonry kN	Dense block kN	Hollow block kN
25	2.3	1.3	1.4	n/a
30	4.3	1.5	2.0	5.0
35	5.2	2.3	2.8	5.4

Hardness Rating (Vickers scale)	
Surface Hardness HV	Core Hardness HV
630.0	430.0

Ultimate mechanical performance	
Tensile Strength kN	Shear Strength kN
10.8	13.0

Influence of Concrete Strength on Performance								
Concrete Strength (As per BS EN 206-1:2000) depth mm	Nominal Embedment Depth mm	Concrete Grade						
		C20/25	C25/30	C30/37	C34/45	C40/50	C50/60	>C50/60
30N/mm ²	32.0	0.70	1.00	1.00	1.10	1.15	1.20	1.25

Advanced Setting Data		
Substrate Type	Category	
n/a	Nominal embedment depth	
Non cracked concrete (>30N/mm ²)	Minimum base material thickness	
	Minimum screw spacing	
	Minimum edge distance	
	Minimum edge distance	
Cracked concrete (>30N/mm ²)	Minimum base material thickness	
	Minimum screw spacing	
	Minimum edge distance	

Influence of Edge Distance on Performance / Influence of Anchor Spacing on Performance										
% of stated minimum	10%	20%	30%	40%	50%	60%	70%	80%	90%	100%
Reduction Factor	0.45	0.55	0.65	0.70	0.70	0.75	0.80	0.85	0.90	1.0

Testing

All test results were derived from empirical testing performed by ETAS (Evolution Testing & Analytical Services) a UKAS (United Kingdom Accreditation Service) accredited testing laboratory (Accreditation No. 7485). The following tests were performed to the following standards.

Test / Parameter	Standard / Method / Procedure
Ultimate Tensile	ISO 6892-1:2009 "Metallic materials – tensile testing – Part 1: Method of test at room temperature."
Ultimate Shear	MIL-STD-1312-13 "Military Standard: Fastener test method (Method 13) Double shear test."
Pull Out (Withdrawal Force)	EN 14566:2009 "Mechanical fasteners for gypsum plasterboard systems. Definitions, requirements and test methods."
Pull Over	EN 14592:2008 "Timber structures. Dowel type fasteners. Requirements."
Hardness	ISO 650 7-1: 2005 "Metallic materials – Vickers hardness test - Part 1: Test Method."
Corrosion Resistance	EN ISO 9227: 2012 "Corrosion tests in artificial atmospheres. Salt spray tests".
Drilling Time Test	EN 14566: 2009 "Mechanical fasteners for gypsum plasterboard systems. Definitions, requirements and test methods."

Aluminium trunking capacity guide

Trunking height up to 150mm

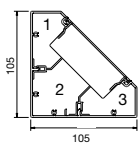

Bench trunking – no box
 1 & 3 = 1842mm² total area
 1 & 3 = 829mm² 45% space factor
 2 = 3342mm² total area
 2 = 1504mm² 45% space factor

With box in comp 2
 2 = 2188mm² total area
 2 = 984mm² 45% space factor
Internal dimensions
 Compartment 1 = 101 x 101mm

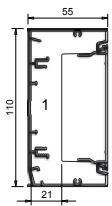

Elegance 110 aluminium – no box
 1 = 5254mm² total area
 1 = 2364mm² 45% space factor
With box in comp 1
 1 = 2987mm² total area
 1 = 1344mm² 45% space factor
Internal dimensions
 Compartment 1 = 107 x 52mm

Trunking height from 150mm to 200mm

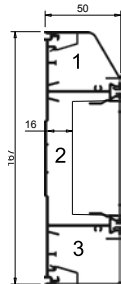

Sterling Profile 2 – no box
 1 = 1060mm² total area
 1 = 477mm² 45% space factor
 2 = 3802mm² total area
 2 = 1711mm² 45% space factor
 3 = 1400mm² total area
 3 = 630mm² 45% space factor

With box in comp 2
 2 = 1535mm² total area
 2 = 691mm² 45% space factor
Internal dimensions
 Compartment 1 = 39 x 45mm
 Compartment 2 = 86 x 46mm
 Compartment 3 = 37 x 45mm

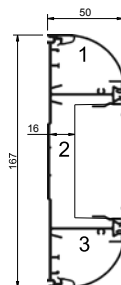

Sterling Curve Aluminium Profile 1 – no box
 1 & 3 = 993mm² total area
 1 & 3 = 447mm² 45% space factor
 2 = 3275mm² total area
 2 = 1474mm² 45% space factor

With box in comp 2
 2 = 959mm² total area
 2 = 432mm² 45% total area
Internal dimensions
 Compartment 1 = 32 x 39mm
 Compartment 2 = 71 x 46mm
 Compartment 3 = 32 x 39mm

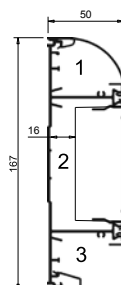

Sterling Curve Aluminium Profile 2 – no box
 1 = 993mm² total area
 1 = 447mm² 45% space factor
 2 = 3275mm² total area
 2 = 1474mm² 45% space factor
 3 = 1035mm² total area
 3 = 466mm² 45% space factor

With box in comp 2
 2 = 959mm² total area
 2 = 432mm² 45% total area
Internal dimensions
 Compartment 1 = 32 x 39mm
 Compartment 2 = 71 x 46mm
 Compartment 3 = 29 x 39mm

Trunking height over 200mm

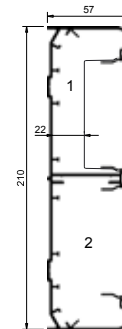

Twin Plus – no box
 1 & 2 = 5000mm² total area
 1 & 2 = 2250mm² 45% space factor
With box in comps 1 or 2
 1 & 2 = 2733mm² total area
 1 & 2 = 1230mm² 45% space factor
Internal dimensions
 Compartment 1 = 95 x 52mm
 Compartment 2 = 95 x 52mm

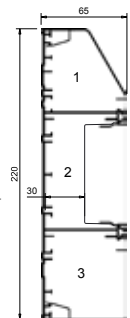

XL302 – no box
 1 = 2680mm² total area
 1 = 1206mm² 45% space factor
 2 = 4639mm² total area
 2 = 2088mm² 45% space factor
 3 = 3490mm² total area
 3 = 1570mm² 45% space factor
With box in comp 2
 2 = 1123mm² total area
 2 = 505mm² 45% space factor
Internal dimensions
 Compartment 1 = 64 x 62mm
 Compartment 2 = 84 x 62mm
 Compartment 3 = 64 x 61mm

To determine cable capacity, select the size of the cable required and its corresponding cable factor from the table. Divide the compartment area figure (with or without 45% space factor) with the cable factor figure to achieve cable capacity.

Conductor type	Size	Cable factor
Stranded PVC power	1.5mm ²	8.6
Stranded PVC power	2.5mm ²	12.6
Stranded PVC power	4.0mm ²	16.6
*Data cable	Ø5.5mm	23.8
*Data cable	Ø6.0mm	28.3
*Data cable	Ø6.5mm	33.2
*Data cable	Ø7.0mm	38.5
*Data cable	Ø8.4mm	55.4

For Data cable information, please see page 242

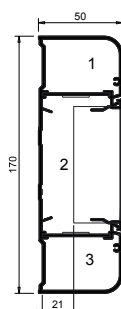

Elegance 170 Aluminium – no box
 1 = 1764mm² total area
 1 = 794mm² 45% space factor
 2 = 4508mm² Total Area
 2 = 2029mm² 45% space factor
With box in comp 2
 2 = 1748mm² total area
 2 = 787mm² 45% space factor
Internal dimensions
 Compartment 1 = 36 x 49mm
 Compartment 2 = 91 x 52mm
 Compartment 3 = 36 x 49mm

Calculations
 Please note that all the above calculations are based on a box depth of 30mm

Bench trunking aluminium

Material

Aluminium trunking is manufactured from high precision extruded aluminium with a powder coat finish.

White RAL 9016

Silver Grey RAL 9006

Accessory boxes are supplied in polycarbonate which is 100% recyclable.

Positioning

Bench and desk installations: a single run can be fitted to rear of furniture or, if run down centre line, two units can be joined back to back presenting accessories on both sides.

Bend radius control

Contact our Technical Team on +44 (0)1424 856688

Screening

Aluminium containment protects internal circuits from external electromagnetic interference. For internal segregation and screening, use a screened dividing fillet.

Dimensions

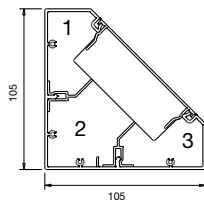

Bench trunking – with box

- 1 = 1345mm² total area
- 1 = 605mm² 45% space factor
- 2 = 2188mm² total area
- 2 = 984mm² 45% space factor
- 3 = 1345mm² total area
- 3 = 605mm² 45% space factor

Bench trunking – No box

- 1 = 1842mm² total area
- 1 = 828mm² 45% space factor
- 2 = 3342mm² total area
- 2 = 1504mm² 45% space factor
- 3 = 1842mm² total area
- 3 = 828mm² 45% space factor

Cable capacities

- All calculations allow for a 45% space factor.

As there can be differences between data cable sizes, Marshall-Tufflex recommend that cable dimensions are confirmed with the manufacturing company.

Cable capacity chart	Compartment 1		Compartment 2		Compartment 3	
	No box	With box	No box	With box	No box	With box
PVC power cable 1.5mm ² stranded copper	40	35	165	116	40	79
PVC power cable 2.5mm ² stranded copper	27	24	112	79	27	24
PVC power cable 4.0mm ² stranded copper	21	18	85	60	21	18
Data cable: Ø5.5mm	14	12	59	41	14	12
Data cable: Ø6.0mm	12	10	50	35	12	10
Data cable: Ø6.5mm	10	9	42	30	10	9
Data cable: Ø7.0mm	9	7	36	25	9	7
Data cable: Ø8.4mm	6	5	25	18	6	5

Only for straight runs. If bends are required please contact the Technical Team on +44 (0)1424 856688.

Elegance Aluminium

Material

Aluminium trunking is manufactured from high precision extruded aluminium with a powder coat finish.

White RAL 9016 (Elegance 110 only)

Silver Grey RAL 9006

Accessory boxes are supplied in polycarbonate which is 100% recyclable.

Positioning

Elegance can be installed at dado level or as a bench-mounted installation.

Screening

Aluminium containment will protect all internal circuits from external electromagnetic interference. For internal segregation metallic dividing fillets are available.

Dimensions

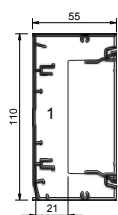

Elegance 110

1 = 5254mm² total area

1 = 2364mm² 45% space factor

With box in comp 1

1 = 2987mm² total area

1 = 1344mm² 45% space factor

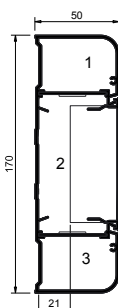

Elegance 170

1 & 3 = 1764mm² total area

1 & 3 = 794mm² 45% space factor

Without Accessory

2 = 4508mm² total area

2 = 2029mm² 45% space factor

With Accessory

2 = 1748mm² total area

2 = 787mm² 45% space factor

Cable capacities

- All calculations allow for a 45% space factor.

As there can be differences between data cable sizes, Marshall-Tufflex recommend that cable dimensions are confirmed with the manufacturing company.

Cable capacity chart Total cables = Volume/cable factor	Elegance 110		Elegance 170			
	Compartment 1		Compartment 1	Compartment 2		Compartment 3
	No box	With box		No box	With box	
PVC power cable 1.5mm ² stranded copper	274	156	92	235	91	92
PVC power cable 2.5mm ² stranded copper	187	106	63	161	62	63
PVC power cable 4.0mm ² stranded copper	142	80	47	122	47	47
Data cable: Ø5.5mm	99	56	33	85	33	33
Data cable: Ø6.0mm	83	47	28	71	27	28
Data cable: Ø6.5mm	72	40	23	61	23	23
Data cable: Ø7.0mm	61	34	20	52	20	20
Data cable: Ø8.4mm	42	24	14	36	14	14

Sterling Profile aluminium

Material

Aluminium trunking is manufactured from high precision extruded aluminium with a powder coat finish.

White RAL 9016

Silver Grey RAL 9006

Sterling Curve is available in Silver Grey only.

Accessory boxes are supplied in polycarbonate which is 100% recyclable.

Positioning

Suitable for dado and skirting. If used for skirting applications, a clearance of 10mm is recommended above the floor covering to maintain IP4X rating.

Bend radius control

Contact our Technical Team on +44 (0)1424 856688

Screening

Aluminium containment will protect all internal circuits from external electromagnetic interference. For internal segregation and screening, use a screened dividing fillet.

Dimensions

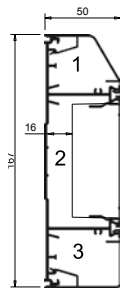

Sterling Profile 2 - no box

- 1 = 1060mm² total area
- 1 = 477mm² 45% space factor
- 2 = 3802mm² total area
- 2 = 1711mm² 45% space factor
- 3 = 1400mm² total area
- 3 = 630mm² 45% space factor

Note: The dimensions shown in this drawing can be used to work out dimensions for Sterling Profiles 1 & 3

Sterling Profile 3002 - with box

- 2 = 1535mm² total area
- 2 = 691mm² 45% space factor

Note: The dimensions shown in this drawing can be used to work out dimensions for Sterling Profile 3001

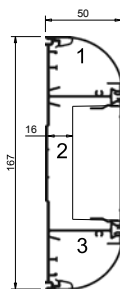

Sterling Curve Aluminium Profile 1 - no box

- 1 & 3 = 993mm² total area
- 1 & 3 = 447mm² 45% space factor
- 2 = 3275mm² total area
- 2 = 1474mm² 45% space factor

With box in comp 2

- 2 = 959mm² total area
- 2 = 432mm² 45% total area

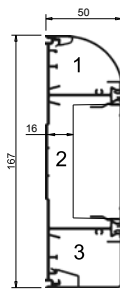

Sterling Curve Aluminium Profile 2 - no box

- 1 = 993mm² total area
- 1 = 447mm² 45% space factor
- 2 = 3275mm² total area
- 2 = 1474mm² 45% space factor
- 3 = 1035mm² total area
- 3 = 466mm² 45% space factor

With box in comp 2

- 2 = 959mm² total area
- 2 = 432mm² 45% total area

Sterling Profile aluminium – continued

Cable capacities

- All calculations allow for a 45% space factor.

As there can be differences between data cable sizes, Marshall-Tufflex recommend that cable dimensions are confirmed with the manufacturing company.

Cable capacity chart	Compartment 1		Compartment 2		Compartment 3	
	No box	With box	No box	With box	No box	With box
PVC power cable 1.5mm² stranded copper						
Sterling Profile 1	52	–	171	50	52	–
Sterling Profile 2	52	–	171	50	54	–
Sterling Profile 3	54	–	171	50	54	–
Sterling Curve Profile 1	51	–	171	50	51	–
Sterling Curve Profile 2	51	–	171	50	54	–
PVC power cable 2.5mm² stranded copper						
Sterling Profile 1	35	–	116	34	35	–
Sterling Profile 2	35	–	116	34	36	–
Sterling Profile 3	36	–	116	34	36	–
Sterling Curve Profile 1	35	–	116	34	35	–
Sterling Curve Profile 2	35	–	116	34	36	–
PVC power cable 4.0mm² stranded copper						
Sterling Profile 1	27	–	88	26	27	–
Sterling Profile 2	27	–	88	26	28	–
Sterling Profile 3	28	–	88	26	28	–
Sterling Curve Profile 1	26	–	88	26	26	–
Sterling Curve Profile 2	26	–	88	26	28	–
Data cable: Ø5.5mm						
Sterling Profile 1	18	–	62	18	18	–
Sterling Profile 2	18	–	62	18	19	–
Sterling Profile 3	19	–	62	18	19	–
Sterling Curve Profile 1	18	–	62	18	18	–
Sterling Curve Profile 2	18	–	62	18	19	–
Data cable: Ø6.0mm						
Sterling Profile 1	15	–	52	15	15	–
Sterling Profile 2	15	–	52	15	16	–
Sterling Profile 3	16	–	52	15	16	–
Sterling Curve Profile 1	15	–	52	15	15	–
Sterling Curve Profile 2	15	–	52	15	16	–
Data cable: Ø6.5mm						
Sterling Profile 1	13	–	44	13	13	–
Sterling Profile 2	13	–	44	13	14	–
Sterling Profile 3	14	–	44	13	14	–
Sterling Curve Profile 1	13	–	44	13	13	–
Sterling Curve Profile 2	13	–	44	13	14	–
Data cable: Ø7.0mm						
Sterling Profile 1	11	–	38	11	11	–
Sterling Profile 2	11	–	38	11	12	–
Sterling Profile 3	12	–	38	11	12	–
Sterling Curve Profile 1	11	–	38	11	11	–
Sterling Curve Profile 2	11	–	38	11	12	–
Data cable: Ø8.4mm						
Sterling Profile 1	8	–	26	7	8	–
Sterling Profile 2	8	–	26	7	8	–
Sterling Profile 3	8	–	26	7	8	–
Sterling Curve Profile 1	8	–	26	7	8	–
Sterling Curve Profile 2	8	–	26	7	8	–

Twin Plus aluminium

Material

Aluminium trunking is manufactured from high precision extruded aluminium with a powder coat finish.
Silver Grey RAL 9006

Accessory boxes are supplied in polycarbonate which is 100% recyclable.

Positioning

Suitable for skirting and architrave. If used for skirting applications, a clearance of 10mm is recommended above the floor covering to maintain IP4X rating.

Bend radius control

The bend radius control fittings for Twin Plus provide a bend radius of 50mm.

Screening

Aluminium containment will protect all internal circuits from external electromagnetic interference. For internal segregation and screening, use a screened dividing fillet.

Dimensions

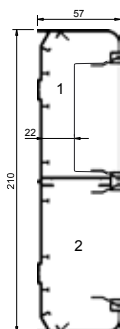

Twin Plus trunking – with accessory box

- 1 = 2733mm² total area
- 1 = 1230mm² 45% space factor
- 2 = 2833mm² total area
- 2 = 1275mm² 45% space factor

Twin Plus trunking – no box

- 1 = 5000mm² total area
- 1 = 2250mm² 45% space factor
- 2 = 5100mm² total area
- 2 = 2295mm² 45% space factor

Cable capacities

- All calculations allow for a 45% space factor.

As there can be differences between data cable sizes, Marshall-Tufflex recommend that cable dimensions are confirmed with the manufacturing company.

Cable capacity chart	Compartment 1		Compartment 2	
	No box	With box	No box	With box
PVC power cable 1.5mm ² stranded copper	261	143	261	143
PVC power cable 2.5mm ² stranded copper	178	97	178	97
PVC power cable 4.0mm ² stranded copper	135	74	135	74
Data cable: Ø5.5mm	94	51	94	51
Data cable: Ø6.0mm	79	43	79	43
Data cable: Ø6.5mm	67	37	67	37
Data cable: Ø7.0mm	58	31	58	31
Data cable: Ø8.4mm	40	22	40	22

XL trunking aluminium

Material

Aluminium trunking is manufactured from high precision extruded aluminium with a powder coat finish.

Accessory boxes are supplied in polycarbonate which is 100% recyclable.

Positioning

Suitable for skirting and architrave. If used for skirting applications, a clearance of 10mm is recommended above the floor covering to maintain IP4X rating.

Bend radius control

For data bend radius control fittings for XL, please contact our Technical Team on +44 (0)1424 856688.

Screening

Aluminium containment will protect all internal circuits from external electromagnetic interference. For internal segregation and screening, use a screened dividing fillet.

Dimensions

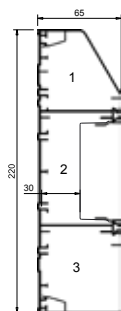

XL302 – no box

- 1 = 2680mm² total area
- 1 = 1206mm² 45% space factor
- 2 = 4639mm² total area
- 2 = 2087mm² 45% space factor
- 3 = 3490mm² total area
- 3 = 1570mm² 45% space factor

XL302 – with box

- 2 = 1123mm² total area
- 2 = 505mm² 45% space factor

Note: The dimensions shown in this drawing can be used to work out dimensions for XL301

Cable capacities

- All calculations allow for a 45% space factor.

As there can be differences between data cable sizes, Marshall-Tufflex recommend that cable dimensions are confirmed with the manufacturing company.

Cable capacity chart	Compartment 1		Compartment 2		Compartment 3	
	No box	With box	No box	With box	No box	With box
PVC power cable 1.5mm² stranded copper						
XL301	140	–	242	58	140	–
XL302	140	–	242	58	182	–
PVC power cable 2.5mm² stranded copper						
XL301	95	–	165	40	95	–
XL302	95	–	165	40	124	–
PVC power cable 4.0mm² stranded copper						
XL301	72	–	125	30	72	–
XL302	72	–	125	30	94	–
Data cable: Ø5.5mm						
XL301	50	–	87	21	50	–
XL302	50	–	87	21	66	–
Data cable: Ø6.0mm						
XL301	42	–	73	17	42	–
XL302	42	–	73	17	55	–
Data cable: Ø6.5mm						
XL301	36	–	62	15	39	–
XL302	36	–	62	15	49	–
Data cable: Ø7.0mm						
XL301	31	–	54	13	31	–
XL302	31	–	54	13	40	–
Data cable: Ø8.4mm						
XL301	21	–	37	9	21	–
XL302	21	–	37	9	28	–

Steel trunking Series 130 and Series 170

Material

Steel trunking is manufactured from pre-galvanised steel with a powder coat finish to RAL 9010.

Positioning

- System 130: suitable for dado installation.
- System 170: suitable for dado and skirting installation.

If used for skirting applications, a clearance of 10mm is recommended above the floor covering to maintain IP4X rating.

Screening

Steel containment protects internal circuits from external electromagnetic interference. For internal segregation and screening, use the steel dividing fillet 351189.

Dimensions

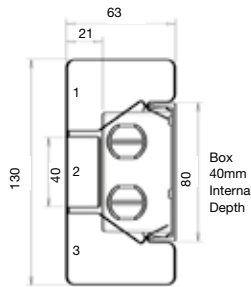

System 130 trunking 130 x 63mm

Compartments 1 & 3 = 1585mm² (each) total area
 Compartments 1 & 3 = 713mm² (each) 45% space factor
 Compartment 2 = 760mm² total area (with box)
 Compartment 2 = 342mm² 45% space factor (with box)

Internal dimensions

Compartment 1 = 128 x 61mm

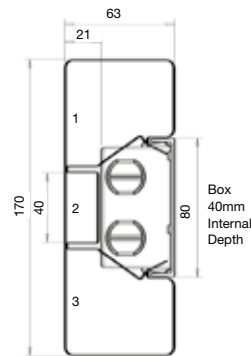

System 170 trunking 170 x 63mm

Compartments 1 & 3 = 2812mm² (each) total area
 Compartments 1 & 3 = 1265mm² (each) 45% space factor
 Compartment 2 = 760mm² total area (with box)
 Compartment 2 = 342mm² 45% space factor (with box)

Internal dimensions

Compartment 1 = 168 x 61mm

p180

Product Information

Cable capacities

- All calculations allow for a 45% space factor.

As there can be differences between data cable sizes, Marshall-Tufflex recommend that cable dimensions are confirmed with the manufacturing company.

Cable capacity chart	Compartment 1		Compartment 2		Compartment 3	
	No box	With box	No box	With box	No box	With box
PVC power cable 1.5mm² stranded copper						
System 130	82	-	-	37	82	-
System 170	147	-	-	39	147	-
PVC power cable 2.5mm² stranded copper						
System 130	56	-	-	25	56	-
System 170	100	-	-	27	100	-
PVC power cable 4.0mm² stranded copper						
System 130	42	-	-	19	42	-
System 170	76	-	-	20	76	-
Data cable: Ø5.5mm						
System 130	30	-	-	13	30	-
System 170	53	-	-	14	53	-
Data cable: Ø6.0mm						
System 130	25	-	-	11	25	-
System 170	44	-	-	12	44	-
Data cable: Ø6.5mm						
System 130	21	-	-	9	21	-
System 170	38	-	-	10	38	-
Data cable: Ø7.0mm						
System 130	18	-	-	8	18	-
System 170	32	-	-	8	32	-
Data cable: Ø8.4mm						
System 130	12	-	-	5	12	-
System 170	22	-	-	6	22	-

To determine cable capacity, select the size of the cable required and its corresponding cable factor from the table. Divide the compartment area figure (with or without 45% space factor) with the cable factor figure to achieve cable capacity.

Conductor type	Size	Cable factor
Stranded PVC power	1.5mm ²	8.6
Stranded PVC power	2.5mm ²	12.6
Stranded PVC power	4.0mm ²	16.6
*Data cable	Ø5.5mm	23.8
*Data cable	Ø6.0mm	28.3
*Data cable	Ø6.5mm	33.2
*Data cable	Ø7.0mm	38.5
*Data cable	Ø8.4mm	55.4

For Data cable information, please see page 242

Series 1 Double sided PowerPole

Code	Description	Quantity
PP36001	250mm adj. slide incl	1 pack
A	NPPFB2 Fixing Bracket	1
B	PHAS1 Adjusting Slide	1
C	PPSN1 Sliding Nut	3
D	PPTC1 Top Cover (white only)	1
E	PL1 Lid 3600mm	2
F	PPMB1 Pole 3600mm	1
G	ESSB1 Single Gang Box	6
I	PPBF3 Base Foot (Metal)	2
J	PPBF1 Base Foot (white only)	1
K	ES1 Spacing Cover	5
L	PPBT1 16mm Bonding Terminal Ass.	1
PPF1KIT	#Fixing Kit	1

Accessory Kits

Accessory kits are available to order using the code PPAKIT and include the items within the above table marked in bold text.

Full installation instructions are included within each pack.

PPF1KIT Fixing Kit includes the following items:

- 8 x M5x8 slotted pan head steel m/c screws
- 6 x M5 internal tooth steel lock washers
- 2 x M5 Nyloc Nut

1400mm Extension Pole body kits available to increase Pole height to 5.0m.

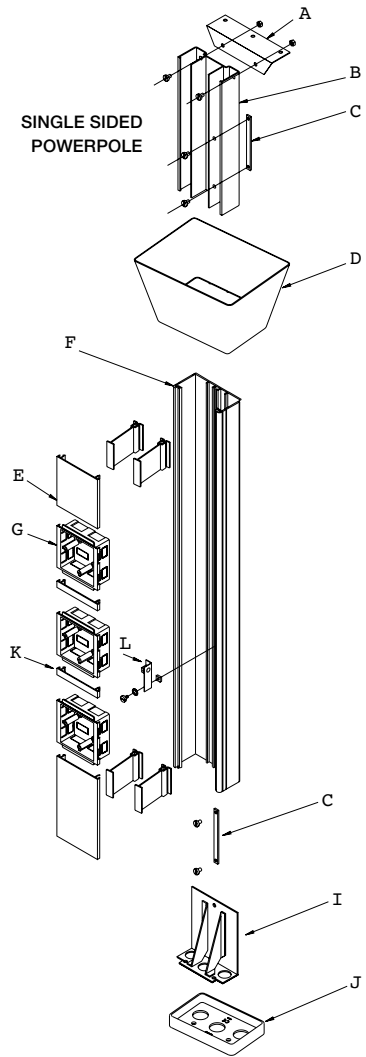
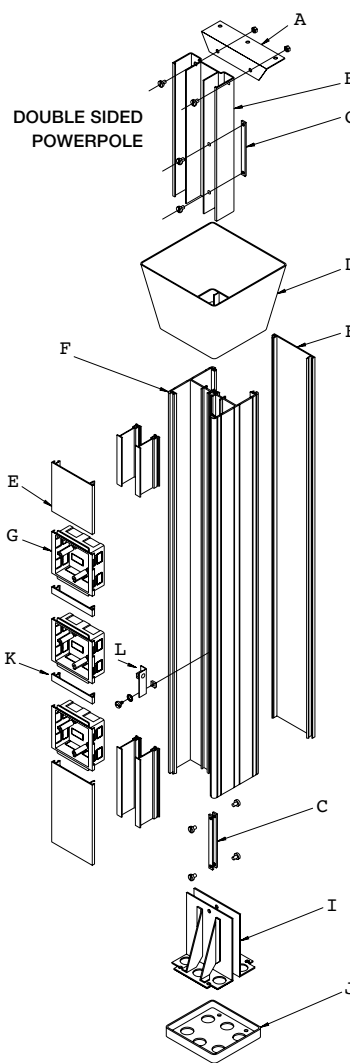

Series 1 Single sided PowerPole

Code	Description	Quantity
PPS36001	250mm adj. slide	1 pack
A	NPPFB2 Fixing Bracket	1
B	PHAS1 Adjusting Slide	1
C	PPSN1 Sliding Nut	2
D	PPTC2 Top Cover (white only)	1
E	PL1 Lid 3600mm	1
F	PPSS1 Single Sided Pole 3600mm	1
G	ESSB1 Single Gang Box	6
I	PPBF3 Base Foot (Metal)	1
J	PPBF4 Base Foot (white only)	1
K	ES1 Spacing Cover	5
L	PPBT1 16mm Bonding Terminal Ass.	1
PPF1KIT	#Fixing Kit	1

Accessory Kits

Accessory kits are available to order using the code PPAKIT2 and include the items within the above table marked in bold text.

Full installation instructions are included within each pack.

PPF1KIT Fixing Kit includes the following items:

- 8 x M5x8 slotted pan head steel m/c screws
- 6 x M5 internal tooth steel lock washers
- 2 x M5 Nyloc Nut

Dimensions and cable capacities

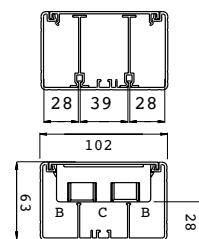
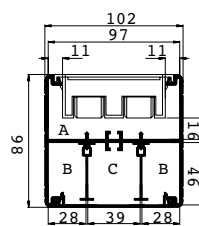

Double sided PowerPole

A = 2017 sq mm total area 45% space factor = 907 sq mm.

Without Accessory Box

A = 4284 sq mm total area 45% space factor = 1927 sq mm.

B = 1148 sq mm total area 45% space factor = 516 sq mm.

C = 1547 sq mm total area 45% space factor = 696 sq mm.

Single sided PowerPole

B = 1115 sq mm total area 45% space factor = 502 sq mm.

C = 1119 sq mm total area 45% space factor = 504 sq mm.

Adjusting slide for PowerPoles

*PowerPoles are suitable for both solid and suspended ceilings up to 3.6 metres high. An alternative adjusting slide which can be extended to one metre is available for additional heights within the ceiling void (part code PHAS2).



Series 2 PowerPole

Double sided PowerPole

with 4 hinged lids and 14 ESSB1WH outlets (NPPE36001441)

Code	Description	Quantity
FF	NPPMB3600A/W# Square PowerPole base 3600mm long	1
A	NPPHLA/W# Hinged lid assembly	4
P	NPPCL1720A/W# Clip on lid 1720mm long	2
Q	NPPCL50A/W# Clip on lid 50mm long	2
R	NPPCL200A/W# Clip on lid 200mm long	2
J	NPPUT Hinged lid upper trim	4
K	NPPLT Hinged lid lower trim	4
GG	NPPTC3 Oval top sliding cover	1
HH	NPPBF5 Oval base foot	1
B	NPPBH1 Bulkhead	8
II	PPBF3 Base foot (galvanised)	2
E	NPPCC1 Cable clip	8
C	ESSB1 Single gang box	14
D	ES1 Spacing cover	12
F	NPPH1 Stainless steel hinges	8
I	PPSN1 Sliding nut	3
H	NPPLH1 Disc latch	12
M	NPPMC1 Magnet catch	12
G	NPPLBS1 Hinged lid bonding strap	4
LBS2	Clip on lid bonding strap	6
L	PPBT1 16mm bonding terminal assembly	1
S	PHAS1 Top adjusting slide 250mm long	1
T	NPPFB2 Top fixing bracket	1
W	MDFS100W1630 100mm dividing fillet 1630mm long	4
Y	MDFS50W710 50mm dividing fillet 710mm long	4
Z	MDFS50W200 50mm dividing fillet 200mm long	4
AA	MDFS15W632 15mm dividing fillet 632mm long	4
JJ	MDFS50W175 50mm dividing fillet 175mm long	4
V	ETL1W633 Sterling lid 633mm long	2

#Please use A or W to denote anodised or white

Full installation instructions are included within each pack.

Dimensions and cable capacities

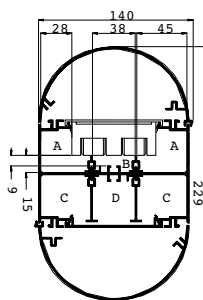
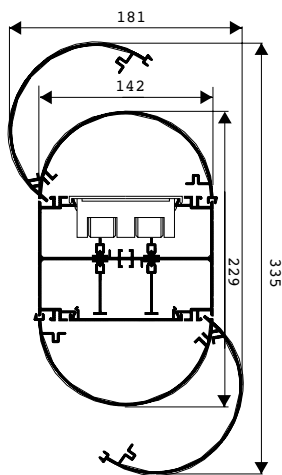

- A = 1313 sq mm total area
45% space factor = 591 sq mm.
- B = 505 sq mm total area
45% space factor = 227 sq mm.
- C = 1798 sq mm total area
45% space factor = 809 sq mm.
- D = 1628 sq mm total area
45% space factor = 733 sq mm.

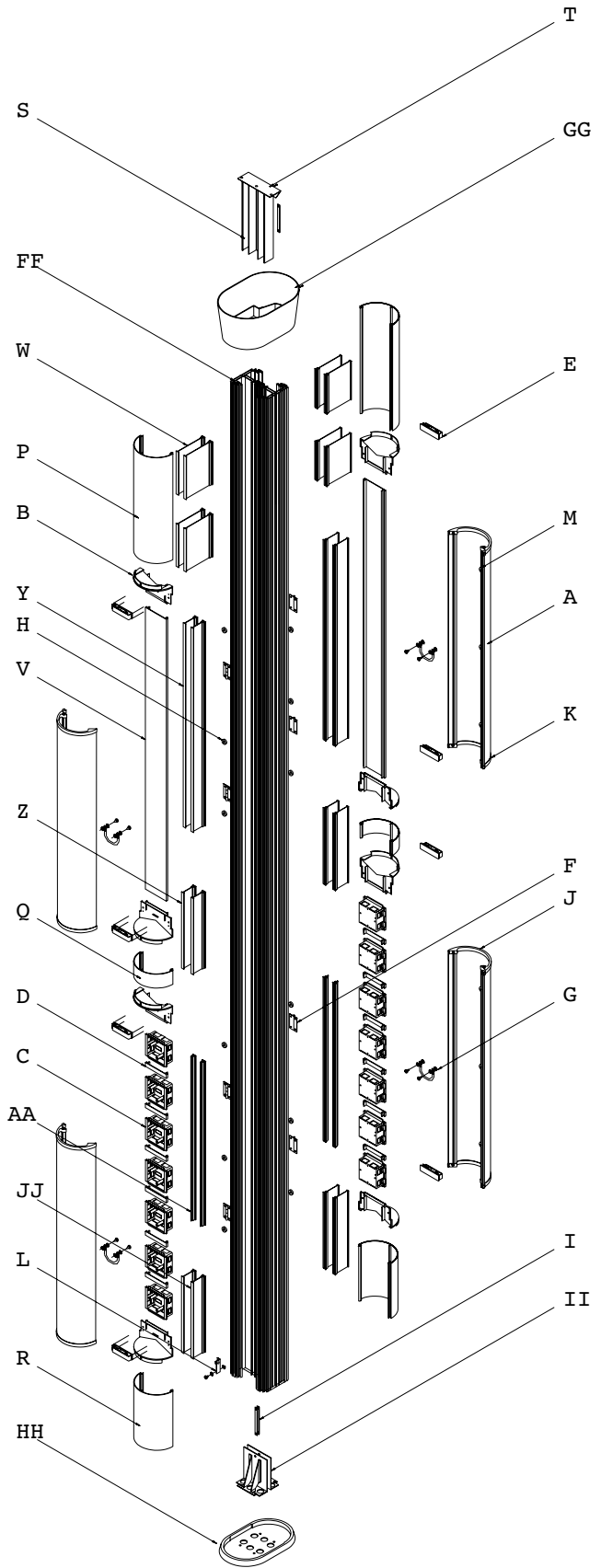

TECHNICAL INFORMATION

p187
Product Information

Series 1 Double sided PowerPost

Code	Description	Quantity
PP685		1 pack
A	PPC1 Cap	1
B	PL2 Lid	2
C	PPMB2 Post	1
D	ESSB1 Single Gang Box	6
E	PPSN1 Sliding Nut	2
F	PPBF3 Base Foot (Metal)	2
G	PPBF1 Base Foot (white only)	1
H	ES1 Spacing Cover	5
L	PPBT1 16mm Bonding Terminal Ass.	1
PPF2KIT	#Fixing Kit	1

The standard height of the PowerPost is 685mm and the overall height, including cap and base, is 692mm.

Full installation instructions are included within each pack.

PPF2KIT Fixing Kit includes the following items:

- 5 x M5x8 slotted pan head steel m/c screws
- 4 x M5 internal tooth steel lock washers
- 1 x M5 Square (8x8x4) pressed steel nut

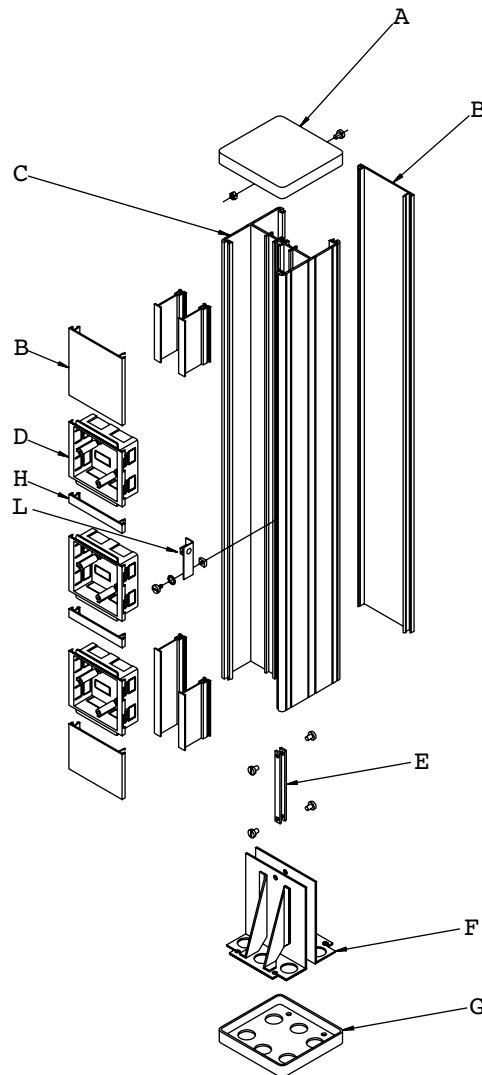

Dimensions and cable capacities

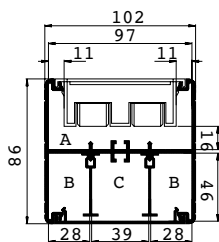

A = 2017 sq mm total area
45% space factor = 907 sq mm.

Without Accessory Box

A = 4284 sq mm total area
45% space factor = 1927 sq mm.

B = 1148 sq mm total area
45% space factor = 516 sq mm.

C = 1547 sq mm total area
45% space factor = 696 sq mm.

MT32 Pre-wired underfloor power distribution

Underfloor Distribution System

Conduit assembly, tap off and adaptor

Cable Type	6491X (BASEC BS 6004 H07V-R)
Protective Earth (P.E)	4.0mm ² x 3 (Grey Plug)
Clean Earth (C.E)	4.0mm ² x 4 (Red Plug)
Protection: Conduit Assembly	25mm Steel flexible conduit (>1KN Tensile Load to BS EN 61386-23)
Protection: Tap Off	20mm Steel flexible conduit (>1KN Tensile Load to BS EN 61386-23)

General specification

Approvals: System	Designed to comply with the latest IET Wiring Regulations BS 7671
Approvals: Connector	Designed to comply with EN 61535:2009 (Fixed installation couplers for permanent connection)
Normal Voltage	250 volts
Frequency	50/60 Hertz
Volt Drop Line & Neutral Connector	1.0 mV/A/M
Volt Drop Line & Neutral (Flexible Cabling System) 2.5mm	19.0 mV/A/M
Volt Drop Line & Neutral (Underfloor) 4.0mm	12.0 mV/A/M
Connector Impedance	1.0m Ω/connector
Connector, Body Material	PA66 – GF25
Connector Colour Female	Black
Connector Colour Male	White
Compatibility	Keyed against incorrect insertion
Operating Temperature (Ambient)	-5°C to + 40°C
Safety	PE contact engages first
Degree of Protection	Engaged IP2XC

Earthing requirements for the installation of equipment having High Protective Conductor currents. BS7671:2018 Reg. 543.7

The scope of Reg. 543.7.1.203 requires that every final circuit intended to supply one or more items of equipment, where the total protective conductor current is likely to exceed 10mA. in normal use, shall have a high integrity protective connection.

Singles Cabling System 4.0mm²

Final Circuit

MT32 singles systems conform to the high integrity protective requirement by virtue of having a single copper protective conductor of 4mm², (Reg 543.7.1.203) with the protective conductor being enclosed throughout in trunking or flexible conduit to provide additional protection against mechanical damage.

Powertrack

Powertrack is an underfloor busbar system rated at 63Amp maximum. It is available in Standard or CE (Clean Earth) versions.

Lengths

- Powertrack lengths of 1.2m, 1.8m, 2.4m and 3.6m with tap-off outlets at 300mm

Safety

- Snap-fit feed units, couplers and tap-offs are key and colour-coded to avoid assembly errors.



Standard = grey



CE = red

- A shutter is operated on insertion to prevent accidental contact.
- Avoid exceeding the maximum power rating of the track. This is ascertained by the maximum power requirement for each floor outlet box

Positioning

- For the most economic format, it is advised that Powertrack is arranged in parallel runs with Powertrack feed units orientated to the incoming supply.
- For optimum layout flexibility, spacing should be a maximum of 5.5m between each length of track and 2.5m from the perimeter when using a standard 3m tap-off to a floor box.

Please refer to the full installation instructions, EL182 available at www.marshall-tufflex.com or by contacting the Technical Team on +44 (0)1424 856688.

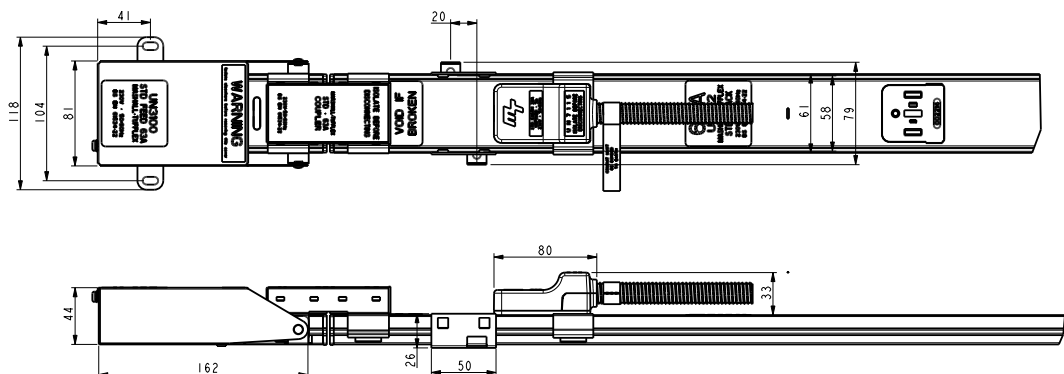
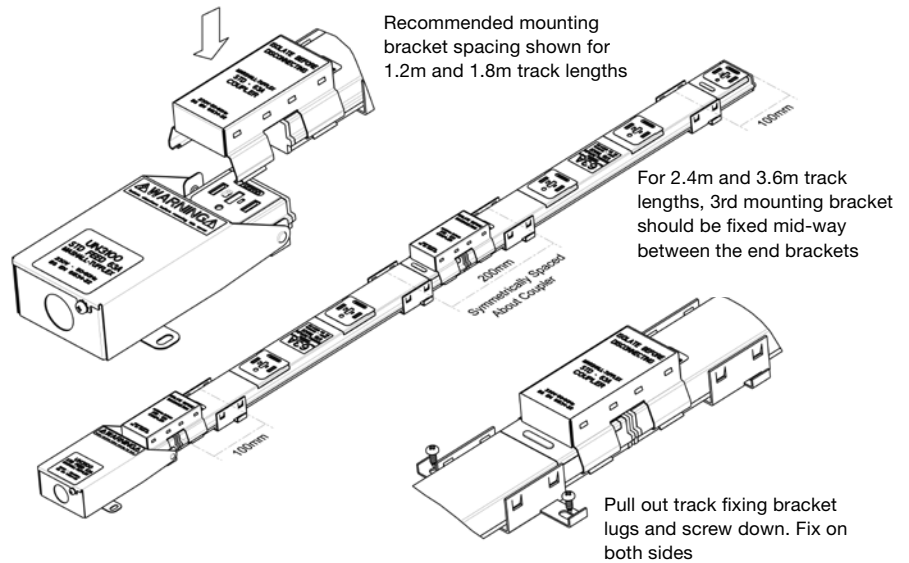

Electrical Characteristics				
Rated Current		63	Amps	
Rated Voltage		230	Volts	
Frequency		50/60	Hz	
Conditional Short Circuit Rating	(Protection device: BS 1361 fuse)	16	KA	
Conductor Resistance Line & Neutral		4.4	mΩ/m	
Volt Drops Line & Neutral	Powertrack	4.4	mV/A/m	
	Feed Unit + Coupler	2.2	mV/A	
	Tap-Off	0.73	mV/A	
	4mm ² Cable	11.0	mV/A/m	
	Coupler	1.5	mV/A	
	Interlink Unit	4.5	mV/A	
Earth Fault Loop Impedance:	16mm ² Cable (1.2m)	3.9	mV/A/m	
	Line to Earth (Casing)	2.8	mΩ/m	
	Line to Earth (Conductor)	3.2	mΩ/m	
	Line to Earth (Conductor + Casing)	2.8	mΩ/m	
	Feed Unit + Coupler	2.2	mΩ	
	Tap-Off	0.73	mΩ	
	4mm ² Cable	11.0	mΩ/m	
	Coupler	1.5	mΩ	
	Interlink Unit	4.5	mΩ	
	16mm ² Cable	3.9	mΩ/m	
	Mechanical Data			
	Number of Copper Conductors		2 or 3	
Conductor Cross-section Area	Nominal	20	mm ²	
Powertrack Casing Copper Equivalent	(Where casing is protective Earth)	12	mm ²	
Cable Termination Capacity		16	mm ²	
Tap-Off Cable 32A		4.0	mm ²	
Tap-Off Cable 13A or 16A		4.0	mm ²	
Tap-Off Conduit Sizes	Rating: Heavy duty conduit <1KN Tensile Load to BS EN 61386-23	Ø20	mm	
Flexible Interlink Cable		16	mm ²	
Flexible Interlink Conduit	Rating: Heavy duty conduit <1KN Tensile Load to BS EN 61386-23	Ø25	mm	
Feed Conduit Entry		1 x Ø25	mm	
IP Rating		40		
Minimum void depth (track + tap-off)		59	mm	
Materials specification				
Powertrack Casing	Galvanised Steel			
Conductors	High Conductivity Copper/brass			
Powertrack Insulators	PBT			
Sockets/Tap-Off Plug/Joint Mouldings	Polycarbonate			
Shutter	PBT			
Tap-Off/Interlink Flexible Conduit	Galvanised Steel			
Tap-Off Cable	BASEC BS 6004 H07V-R			
Tap-Off/Coupler Blade	Copper			
Feed Unit Case	Galvanised Steel			
Flexible Interlink Cable	BASEC BS 6004 H07V-R			
Feed/Flexible Interlink Housing	Galvanised Steel			

Technical Specifications

Third party certified and tested to comply with:

BS EN 61534-1: 2011

BS EN 61534-22: 2009

BS 5733: 1995 where applicable.

Marshall-Tufflex is registered by BSI to BS EN ISO 9001: 2008

MT Powertrack is designed to comply with the current version of the BS 7671 Wiring Regulations.

ASTA Type Test Certification

Powertrack is independently tested by Intertek to BS EN 61534-22:2009 clauses 15.4, 18.4.3.2, & 18.4.3.3

Regulation 543.7 Installations to BS 7671:2018 Earthing requirements for the installation of equipment having High Protective Conductor currents.

The scope of Reg. 543.7.1.203 requires that every final circuit intended to supply one or more items of equipment, where the total protective conductor current is likely to exceed 10mA. in normal use, shall have a high protective connection.

All MT Powertrack tap-off units conform to the high integrity protective requirement by virtue of using a protective conductor of 4mm² enclosed within a flexible conduit, thus providing additional protection against mechanical damage. Regulation 543.7.1.203.

32Amp 3 metre tap-off unit

The 32Amp tap-off unit comprises of an unfused tap-off* a flexible metal conduit with integral 4mm² conductors.

These units are designed to comply with regulation 434.2.1(i) of BS7671:2018 by virtue of the following:

- 1 Maximum length of cable is <3 metres.
- 2 Minimum risk of faults as the item is factory assembled and fully tested.
- 3 Fully protected by flexible steel conduit located within raised access floor that offers further protection.

*Fused 3 metre tap-offs are available if required.

5 metre tap-off unit

Tap-off units in excess of 3 metres should only be used if they contain a fuse or the powertrack is protected by a 32Amp rated protective device.

Raised floor boxes

Three and four compartment boxes and a range of grommets that can be configured to meet client requirements for accessing multiple services concealed below a raised floor system.

Technical specifications

Raised floor boxes are third party tested to comply with:

BS EN 61534-22:2009

BS EN 60670-1:2005

BS EN 60670-23:2008

BS EN 50085-1:2005

BS EN 50085-2-2:2008

Material

- Lid/trim: flame retardant polypropylene grey RAL 7011
- Box assembly: galvanised steel
- Load plate: 3mm zinc plated steel
- Accessory plate: galvanised steel

Dimensions

- For dimensions of non standard boxes and trims, contact our Technical Team on +44 (0)1424 856688.

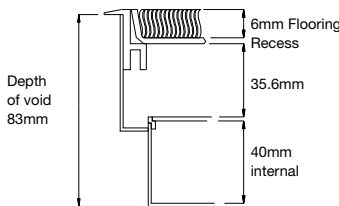
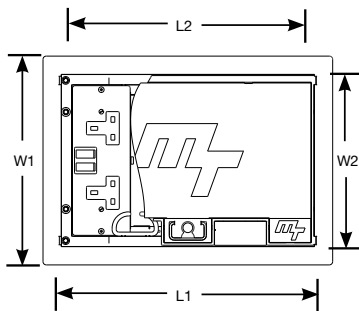

Dimensions

No of compartments	Nominal trim size (L1 x W1)	Cut out dimensions (L2 x W2)	Accessory Plate Dimensions
3	357 x 257mm	322 x 222mm	185 x 95mm
4	357 x 257mm	322 x 222mm	185 x 71mm
		General tolerance +3mm	

Care should be taken to ensure that box edges are smoothed and free from burrs. Carpet tile cut size for lid is 303 x 166mm.

Load testing

Load testing of floor boxes to:

BS EN 61534-22:2009

BS EN 50085-2-2:2008

The floor boxes have been tested to and comply with the loading requirements of the aforementioned standards.

There are two loading criteria for the floor boxes:

1. A point loading; to simulate foot traffic or light furniture like a chair leg / caster sitting on the lid. The maximum permissible deflection is 6mm (BS EN 61534-22:2009 and BS EN 50085-2-2:2008)
2. A plate loading; to simulate heavy foot traffic or larger furniture loads. the maximum permissible deflection is 4mm (BS EN 61534-22:2009) or 6mm (BS EN 50085-2-2:2008)

Note: The maximum permissible permanent deflection after the load has been removed is 3mm for both standards.

The loading graphs show the deflection based on floor boxes without and with a sub-frame. The point loading value is approaching ¼ of a metric tonne without sub-frame and reaching ¼ of a metric tonne with sub-frame. In both cases the permanent deflection is less than 0.25mm.

For plate loading without sub-frame the value is approaching ¼ of a metric tonne with 4mm deflection and ¼ of a metric tonne with 6mm deflection. With the sub-frame fitted the loading reaches ¼ of a metric tonne with 4mm deflection and ½ a metric tonne with 6mm deflection. In both cases the permanent deflection is reaching 0.5mm.

Note: floor boxes fitted with sub-frame can exceed more than 1 metric tonne plate load before lid failure. In all tests (with and without sub-frame) the required loading was reached without damage to the plastic trim or compromised the lid.

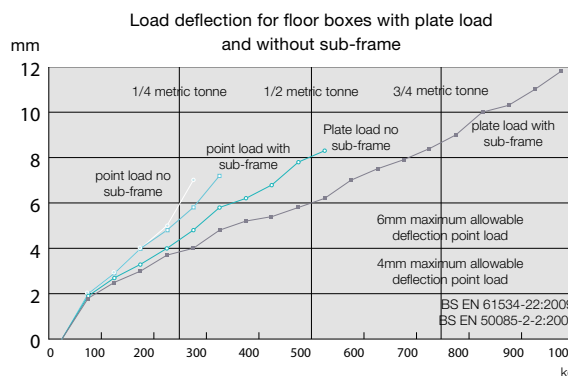

Grommets

Material

- ABS Flame retardant
- Flammability: UL94 V-0 at 2.0mm
- Colour: polypropylene grey RAL 7011
- Lid: captive screwdown
- Lid recess: 15mm for extra strength
- Through power/data options

Dimensions

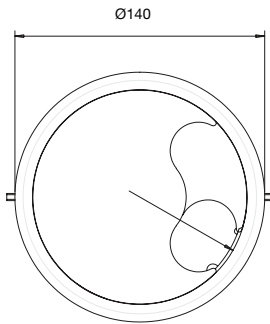

Cut out dimensions

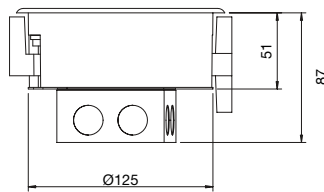

In-screed system

Three and four compartment boxes configured to meet client requirements for accessing multiple services concealed within an in-screed floor system.

Standard system is suitable for screed depths of 65mm to 85mm. For other screed depths please contact our Technical Team on +44 (0)1424 856688.

Material

- Lid/trim: polypropylene grey RAL 7011
- Frame assembly: galvanised steel
- Modular boxes: galvanised steel
- Load plate: galvanised steel

Wiring accessories and mounting plates

- 3 compartment box: 185 x 95mm
- 4 compartment box: 185 x 71mm
- For use with standard 60.3mm and 120.6mm accessories with blank or pre-punched plates for data/telecoms etc.

Junction box

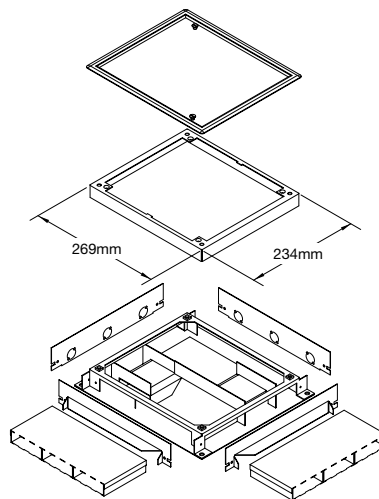

Floor outlet box

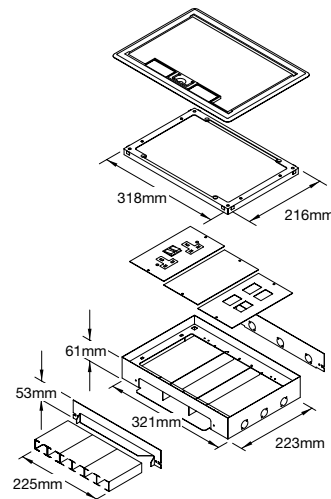

Box screed depth adjustment

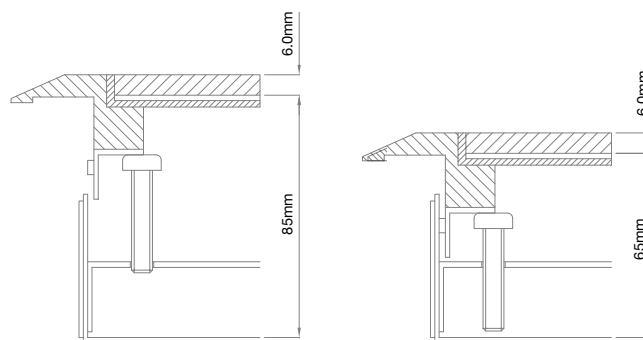

Desk grommets

Dimensions

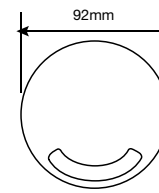

Cut out size

Box type	Diameter
DG1	80mm
General tolerance	2mm

Power and data modules

Standards

BS 1363-1

BS 1363-2 (where applicable)

BS 5733:2010+A1:2014

EN 50581:2012

EN 301 489-34(2012)

IEC 60884-1:2005

For more information please contact our Technical Team on +44 (0)1424 856688.

Material

Power and Power and Data Modules are constructed from high strength flame retardant black polycarbonate mouldings. RCBO – constructed from aluminium casing.

Insulation

Reinforced insulation.

Earth bonding:

- **Power Modules**
An external earth terminal allows connection of earth bonding leads without dismantling the unit. Please use suitable tools to cut earth lead from Power Modules if required.
- **Power and Data Modules**
Our Power and Data Modules units are supplied as standard with a prefitted 250mm earth lead to 5mm ring terminal.

Fusing

To enable compliance to BS 6396 the UK sockets are fitted with Ø5 x 20mm anti-surge ceramic fuses, with colour-coded fuse clips to denote the rating (3.15Amp or 5Amp).

RCBO rating

30mA 16Amp

Quality and testing:

100% testing – continuity, polarity, insulation & earth

- **Power and Data Modules only**
- USB charger: Output voltage and resistance
- Data & AV: All sockets continuity tested

Dimensions

Power modules

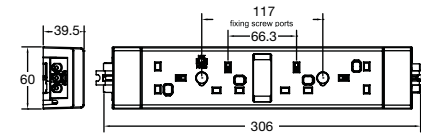
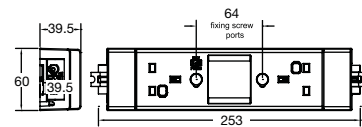

Power and data modules

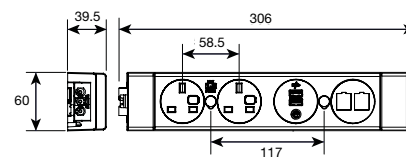

Cable type

In-feed power cable shown with optional Wieland connector.

- 13Amp rating
- Specification of cable length is necessary

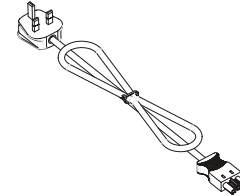

Power module earth lead

Size: 1.5mm²

Length: 250mm with 5mm ring terminal.

Configuration

- **Power modules**
Power only
- **Power and data modules**
2 x UK fused sockets plus 2 configurable gangs for Power, USB charging or data/AV
- **RCBOs**
Designed to be connected directly to underfloor track.
- Input connections via tap-off.
- Output connection via Wieland GST18/3.

Connection options

Power and Data Modules - Built in GST18/3 male for power in, plus optional GST18/3 female connector for power out on certain configurations.

Two modules units can be securely clipped together via the inbuilt GST18/3 connectors e.g. a DM5001 and DM5030 (both with 3.15Amp fuses) can be joined to form a BS 6396 compliant 6 socket unit.



The rear section of the Power and Data Modules can be removed for onsite data/AV installation.

GRP ladder and tray

Overview

GRP (Glass Reinforced Polyester) has, good stability to UV, great mechanical strength and is 40% lighter than steel. GRP is a non-conductive insulating material, resistant to temperatures from -80°C to +130°C and has excellent resistance to fire and corrosion being self-extinguishing and zero halogen.

Standards and Approvals

- IET Wiring Regulations BS 7671
- (LVD) 2014/35/EU
- Low Voltage Directive

Mechanical Behaviour

- Breaking point to NEMA FG1
- IEC 61537
- Tensile strength at break point to ISO 527-5
- Modulus of elasticity to ISO 527-5
- Accelerated aging to ISO 4892-2 & ISO 9227

Electrical Behaviour

- Surface resistivity to IEC 6079-0
- IEC 60093
- Breakage voltage to IEC 60243-1
- Comparative tracking index IEC 60112

Density to DIN 53479

- Linear Thermal Dilatation to DIN 53752
- Water Absorption to ISO 62

Fire Behaviour

- Inflammability to IEC 60695-2-12/UL94
- UL 723
- DIN 5510-2
- NF-F-16101
- Spread of flame to BS 476 part 7 class 2/ ASTM E84 (Up to Class 1 on request)
- Fire propagation to BS 476 Part 6
- Smoke emissions to BS 6853 App B53
- Fire standard to DIN 4102 part 12
- Reaction to fire classification: M1

GRP tray

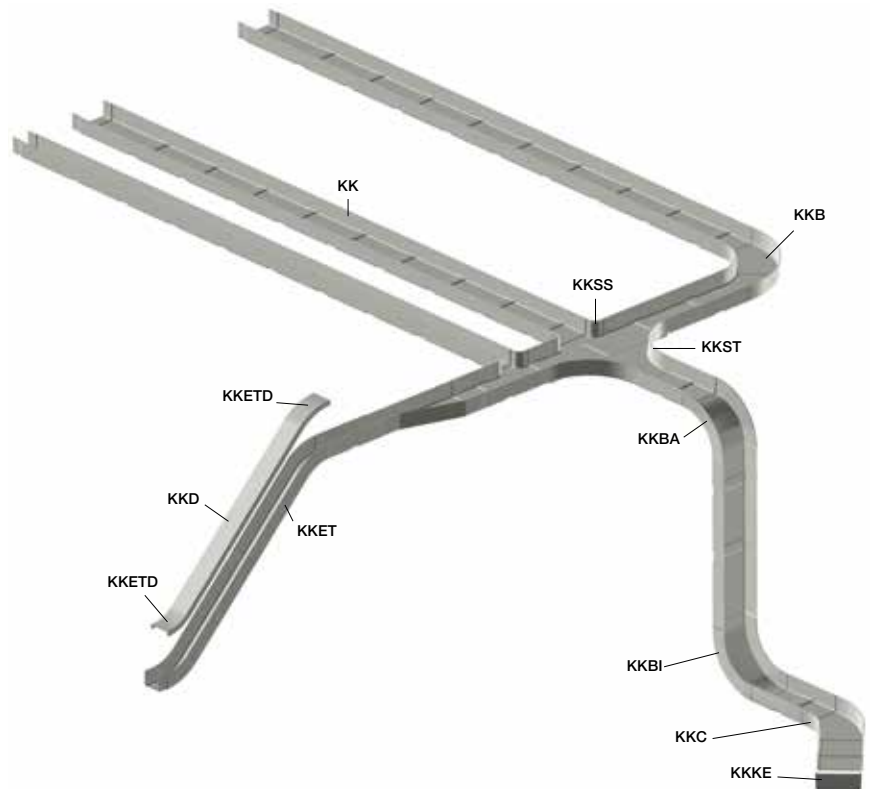

KKB

During installation care must be taken to position a support at each end of the cable tray fitting. It is also recommended that the large radius fitting is fixed laterally to each end of adjoining cable tray.

KK

Each length of tray comes complete with built in, self adjusting coupler. An expansion gap of 8mm must be considered for thermal movement.

KKSS

During installation care must be taken to position a support at each end of the cable tray fitting.

KKST

During installation care must be taken to position a support at each end of the cable tray entry.

KKRR

During installation every reducer must be supported at each end. It is also recommended that the reducer fitting is fixed laterally to each end of adjoining cable tray.

KKBA

During installation care must be taken to position a support at each end of the cable tray entry. It is also recommended that the outside elbow fitting is fixed laterally to each end of adjoining cable tray.

KKETD

Covers are attached using either DF50/DF80 stainless steel cover clips. In strong winds the quantity of clips should be increased.

KKD

For a stronger assembly, covers with a width greater than 400mm are strengthened. Strengthening ribs are visible on the outside of the cover. Covers are attached using either DF50/DF80 stainless steel cover clips. Under normal conditions use 3 clips alternatively on each side per 3 metres of ladders/trays. Under extreme conditions (strong winds >60km/h) use 7 clips per 3 metres of ladder/tray.

KKET

During installation all fittings must be supported at every cable entry, and central support for all fittings with a radius greater than 250mm, and/or with width greater than 400mm. It is also recommended that the change in elevation fitting is fixed laterally to each end of adjoining cable tray.

KKBI

During installation care must be taken to position a support at each end of the cable tray entry. It is also recommended that the inside elbow fitting is fixed laterally to each end of adjoining cable tray.

KKC

To ensure correct installation, the horizontal elbow must be fixed laterally to each end of the adjoining cable tray.

KKKE

Mounting accessories required for this fitting – 2 x M6x16 Bolts (to be ordered separately).

p211

Product Information

Standard span pressed tray

Load characteristics

Coefficient of safety > 1.7 (in accordance with IEC 61537) this data is given for ladders coupled with splice plates and bolts.

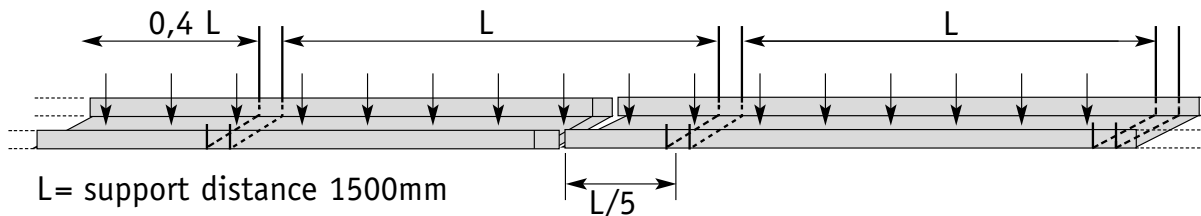

L = support distance 1500mm

The deflection values are measured with the position of the junction between 2 ladders at a distance $L/5$ from a support. If this distance is not respected, it is necessary to raise the deflection values by about 30% when fully loaded.

	Useful area (mm ²)	Weight of cables kg/m	Maximum admissible load kg/m according to the distance between supports				
			2m	3m	4m	5m	6m
UL...53	150 – 300	4420 – 9520 = 250	160	50			
	400 – 600	12920 – 19720 = 550		50			
UL...80	150 – 300	7690 – 16840 = 450	160	160	60	30	
	400 – 600	22940 – 35140 = 1000		160	60	30	

Optimal conditions, for cost reduction on your installation.

Series UL load diagram: supporting distances from 2 to 5m. For 100mm and 150mm wall height refer to Marshall-Tufflex.

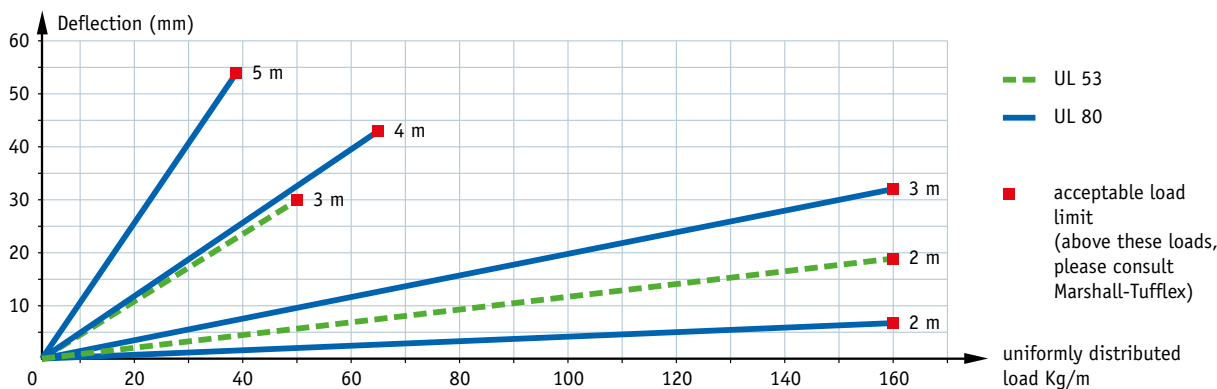

Localised loads

To be able to compare this to a uniformly distributed load it is necessary to double the value of the localised load. Example: A 60kg local load at the centre of a ladder with 3m of support distance. Equivalent load: $60 \times 2 = 120\text{kg}$ uniformly distributed along 3m (ie 40kg/m).

Loading characteristics

- Deflection <5mm (1/300).
- Coefficient of safety >1.7 (in accordance with IEC 61537) using the interlocking and self-adjustable coupling without fasteners.
- Loading diagram details (below) in accordance with IEC 61537, at an ambient temperature of 25°C.

GRP pultruded ladder

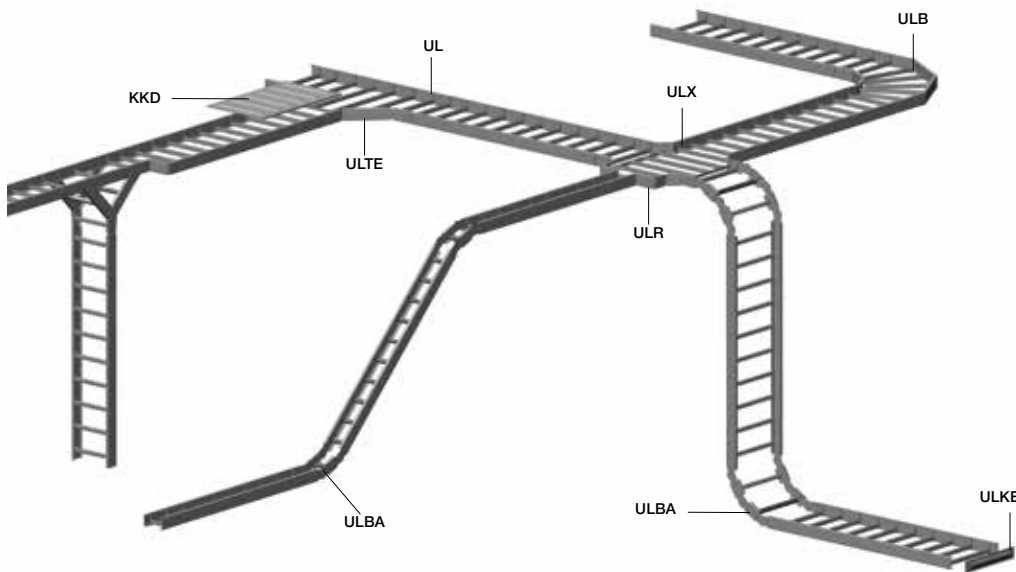

ULB

During installation you must take care to position a support under each elbow at each cable ladder end. If the bending radius is greater than 250mm and/or the width greater than 400mm, an additional intermediary support is necessary.

UL

Cable ladders are supplied with non-perforated rungs. Should you require perforated ladder rungs please contact a member of the technical team who will be happy to assist in your enquiry.

ULX

During installation all fittings must be supported at every cable entry. A central support is required for all fittings with a bend radius greater than 250mm and/or the width greater than 400mm

ULR

During installation the stainless steel splice plates must be fixed on each cable ladder end using 8 x M6 x 16 bolts. (to be ordered separately)

KKD

For a stronger assembly, covers with a width greater than 400mm are strengthened. Strengthening ribs are visible on the outside of the cover. Covers are attached using either DF50/DF80 stainless steel cover clips. In strong winds the quantity of clips should be increased.

ULTE

During installation all fittings must be supported at every cable entry. A central support is required for all fittings with a bend radius greater than 250mm and/or the width greater than 400mm

ULBA

During installation the metallic splice plates must be fixed at each cable ladder end using 4 x M6 x 16 bolts. (to be ordered separately). If the bending radius is greater than 250mm and/or the width greater than 400mm, an additional intermediary support is necessary.

ULKE

Mounting this accessory requires 2 x M6 x 16 bolts. (to be ordered separately)

Load characteristics

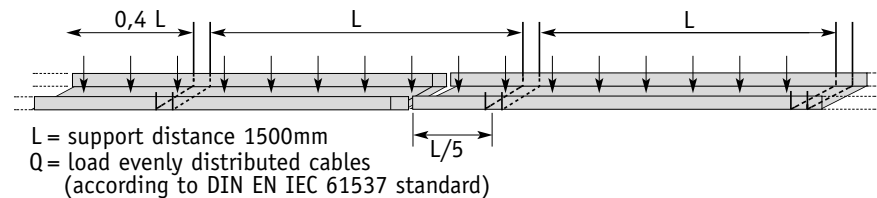

53mm High Cable Ladder

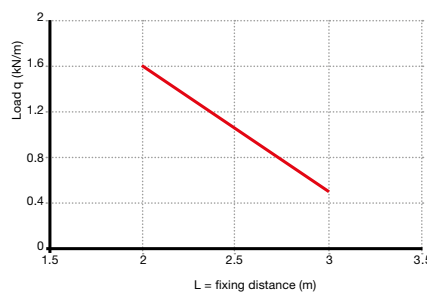

80mm High Cable Ladder

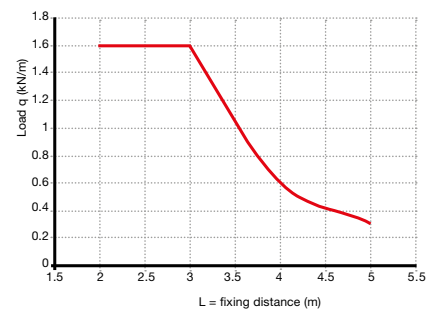

100mm High Cable Ladder

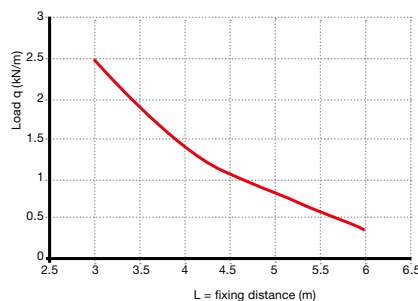

150mm High Cable Ladder

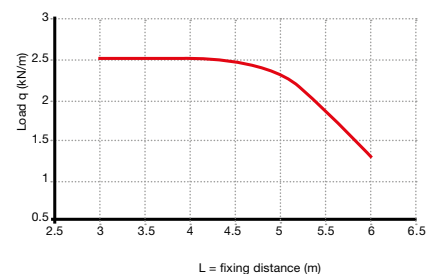

Warning: the deflection is measured with a junction position between 2 cable trays at a distance of L/5 from the support. If this distance is not respected, it is necessary to raise the deflection values by approx 30%.

GRP ground ducts

Load characteristics of ground duct

BK Height 140 mm

F = Deflection
L = Support Distance
Q = Distributed Load

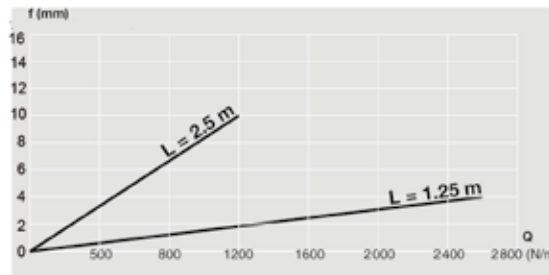
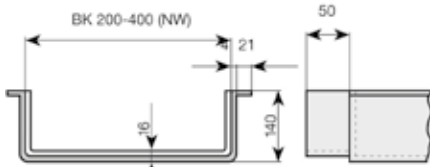

BK Height 176 mm

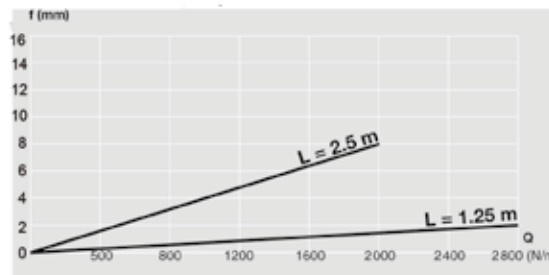
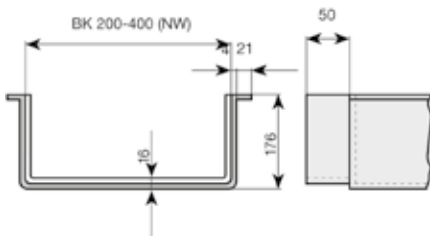

Tested in normal conditions of use

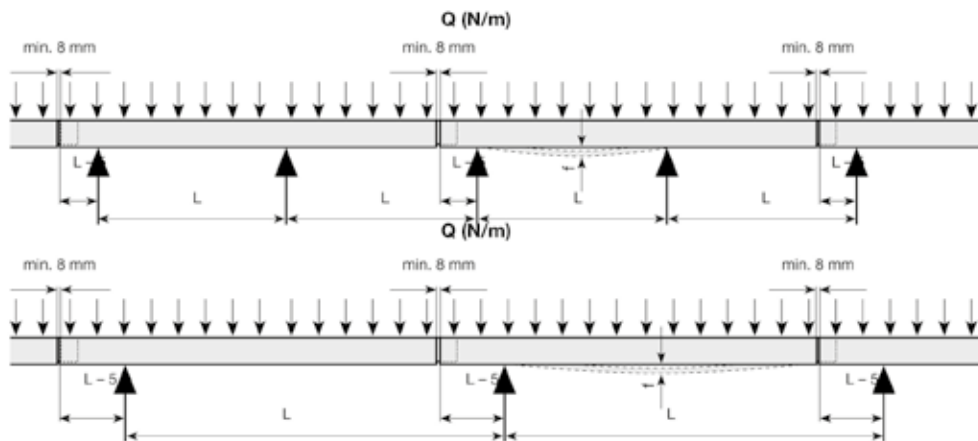

Load diagrams of plate covers

P = Load in N
f = Deflection
NW = Nominal width BK

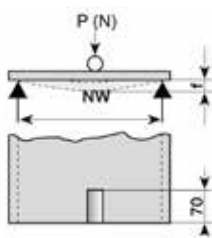

Load at edge of piece

BKDR 5mm

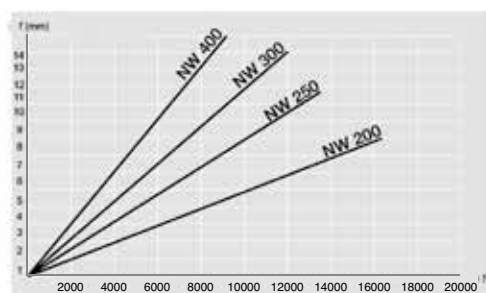

BKDR 8mm

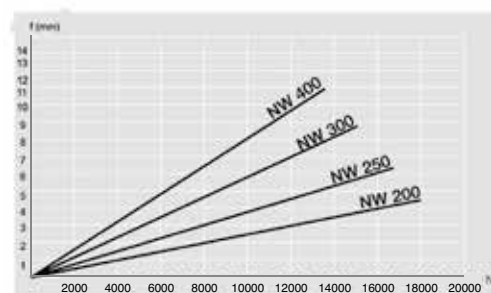

Material

Electrogalvanised (ELECTROZINC/EZ)

A steel base coated with a zinc layer by electrolysis, by means of submerging the lengths in a bath composed of a zinc solution, in accordance with BS EN ISO 2081. Depending on the type of zinc layer, it shall have a different degree of protection on the steel, avoiding corrosion and enhancing the visual appearance of the length. This treatment is carried out once the length has been formed. The IEC 61537 Standard classifies the degree of resistance to corrosion of the system's components depending on the steel's electrolytic covering, belonging to Class 1 those with a minimum thickness of 5µm and to Class 2 those of 12µm. Marshall-Tufflex uses Class 2 as its standard material in order to guarantee the quality of its products against corrosion. This treatment is used in dry environments free of pollutants.

Hot Dip Galvanised Steel (HDG) Non-standard material

Laminated or rust removed galvanised after forming steel according to BS EN ISO 1461 Standard. The steel's protection is covered by a zinc coating which varies depending on the steel's thickness, offering a uniform covering. The zinc coating's thickness depends on the thickness of the base material. The IEC 61537 Standard classifies the resistance against corrosion of these galvanised steels as Class 5 for the covering of 45µm, Class 6 for 55µm, Class 7 for 70µm and Class 8 for 85µm. Hot dip galvanised steel is used in humid environments, granting a high protection during adverse atmospheric situations, light chemical situations, light marine situations and urban situations.

Stainless Steel AISI 316 (I316) Non-standard material

Denominated 14401 according to the numerical classification established by the BS EN 10088 Standard. Steel's protection happens due to the great affinity which metals such as chromium have with oxygen, which gives place to the creation of a protective chromium oxide layer which avoids the corrosion of iron. Type I316 stainless steels are similar to type 1304, but they contain a 2.5% of molybdenum which confers it a greater resistance to localised corrosion. It is ideal for use in very corrosive environments, even at high temperatures. Under special conditions, and always under order, there is the possibility of conducting a passivation process. Passivation is a treatment which enhances stainless steel's protection against corrosion by means of forming a relatively inert film on the surface of a material which protects it against the action of external agents. The passivation

film or layer does not allow these agents to interact, reducing or stopping the chemical reaction from happening.

IEC 61537 Standard classifies this steel's resistance to corrosion as Class 9B without the passivation treatment and as Class 9D with the passivation treatment.

Stainless Steel AISI 316L, denominated 14401 according to the numerical classification established by the BS EN 10088 Standard has the same characteristics regarding corrosion as steel AISI 316, but offers a higher degree of welding and easier forming of the lengths with a thickness of more than 6mm.

Dimensions

Height 35mm

Standard Wire Basket

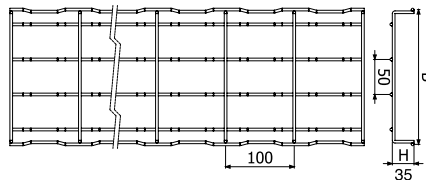

Please note:
B is equal to listed width of basket.

Height 65mm

Fast-Coupling Wire Basket

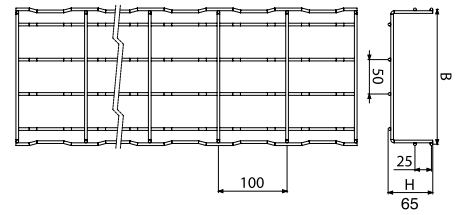

Height 105mm

Fast-Coupling Wire Basket

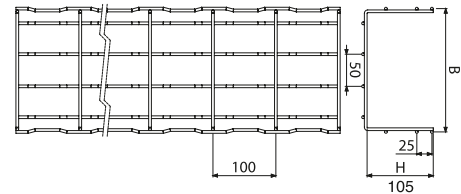

Cover

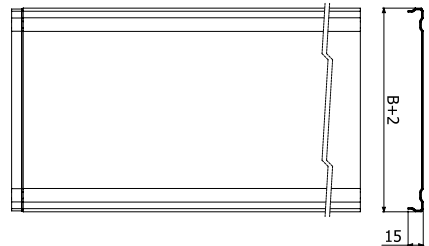

Working temperature

	Minimum working temperature	Maximum working temperature	According to Standard
Standard Wire Basket 35mm	-50°C	+150°C	IEC 61537
Fast-Coupling Wire Basket 65mm	-50°C	+150°C	IEC 61537
Fast-Coupling Wire Basket 105mm	-50°C	+150°C	IEC 61537

Resistance to corrosion

Atmospheric corrosion

Atmospheric corrosion happens when metal is exposed to liquids, solids or gases. Humidity, salt corrosive gases and dirt are its main factors. Atmospheric corrosion takes place in open air conditions, areas with poor ventilation and marine environments.

Saline corrosion happens when a metallic surface is exposed to different saline concentration levels forming a galvanic pile. At times where the surface is exposed to the lowest degree of saline concentration this will then behave as an anode for the corrosion to take place.

Chemical corrosion

Chemical corrosion happens when metal is directly exposed to chemical solutions. Depending on the concentration of the solution, contact time, cleaning frequency and ambient temperature the level of corrosion will be higher or lower.

Galvanic corrosion

Galvanic corrosion is the most common type of corrosion, and happens when two different metals are in contact with one another. When two different metals come into contact a small galvanic particle is created, as one metal acts as an anode the other acts as a cathode. The metal with the most negative reduction potential shall oxidise whilst the metal with the most positive charge shall have less corrosion.

Storage conditions

The product must be stored in a dry and well ventilated area. The product must not be stored outside even in low humidity conditions.

Free base area

Base size	Classification	Free base area
60	Y	Over 80% and up to 90%
100	Y	Over 80% and up to 90%
150	Y	Over 80% and up to 90%
200	Y	Over 80% and up to 90%
300	Y	Over 80% and up to 90%
400	Y	Over 80% and up to 90%
500	Y	Over 80% and up to 90%
600	Y	Over 80% and up to 90%

To show the installation designer the level of ventilation allowed for the cable tray, the IEC 61537 standard established that the manufacturer has to inform of the percentage of the base 'free' (without material, in solid cable trays this means the "degree of perforation").

Safe working load (SWL)

The safe working load (SWL) is the maximum load which can be applied during normal use, without danger. Therefore, the workload shall always be less than the SWL.

The SWL of our products are calculated in accordance with IEC 61537. For any further information contact our Technical Team in +44 (0)1424 856688.

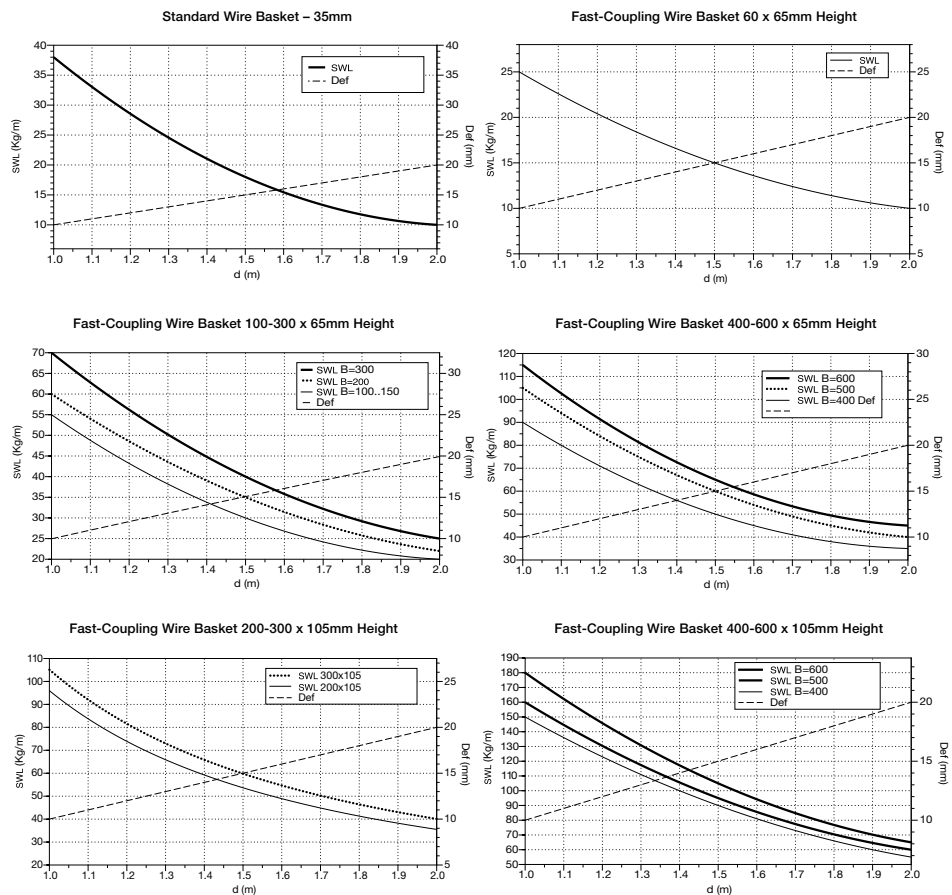

Please note:
 d is equal to distance between supports
 Def = deflection

Cable capacities

- All calculations allow for a 45% space factor.

As there can be differences between data cable sizes, Marshall-Tufflex recommend that cable dimensions are confirmed with the manufacturing company.

Basket Width (mm)	35mm Standard Basket			65mm Fast-coupling Wire Basket			105mm Fast-coupling Wire Basket		
	Without Matting	Flexible Matting	Rigid Matting	No Cablelay	With Cablelay Matting	With Cablelay Rigid	No Cablelay	With Cablelay Matting	With Cablelay Rigid
Data Cable: Ø5.5mm									
60	-	-	-	43	39	41	-	-	-
100	51	42	46	89	80	84	-	-	-
150	79	65	72	142	127	134	-	-	-
200	109	89	99	193	173	183	365	345	355
300	168	137	152	297	266	281	562	531	546
400	-	-	-	401	358	380	759	716	738
500	-	-	-	505	451	478	956	902	929
600	-	-	-	609	544	577	1153	1088	1120
Data Cable: Ø6mm									
60	-	-	-	36	33	34	-	-	-
100	42	35	39	74	67	71	-	-	-
150	66	54	60	119	107	113	-	-	-
200	92	75	83	162	145	153	307	290	298
300	141	115	128	249	223	236	472	446	459
400	-	-	-	337	301	319	638	602	620
500	-	-	-	424	379	402	803	758	781
600	-	-	-	512	457	485	969	914	941
Data Cable: Ø6.5mm									
60	-	-	-	31	28	29	-	-	-
100	36	30	33	63	57	60	-	-	-
150	56	46	51	101	91	96	-	-	-
200	78	64	71	138	124	131	261	247	254
300	120	98	109	212	190	201	402	380	391
400	-	-	-	287	256	272	543	513	528
500	-	-	-	362	323	342	684	646	665
600	-	-	-	436	389	413	825	779	802
Data Cable: Ø7mm									
60	-	-	-	26	24	25	-	-	-
100	31	26	28	54	49	52	-	-	-
150	49	40	44	87	78	83	-	-	-
200	67	55	61	119	106	113	225	213	219
300	104	84	94	183	164	173	347	327	337
400	-	-	-	247	221	234	468	442	455
500	-	-	-	312	278	295	590	557	573
600	-	-	-	376	336	356	712	671	691
Data Cable: Ø8.4mm									
60	-	-	-	18	16	17	-	-	-
100	21	18	20	38	34	36	-	-	-
150	34	28	31	60	54	57	-	-	-
200	47	38	42	82	74	78	156	148	152
300	72	58	65	127	114	120	241	227	234
400	-	-	-	172	153	163	325	307	316
500	-	-	-	216	193	205	410	386	398
600	-	-	-	261	233	247	494	466	480

Load table

Find out the load capacity of all our wire baskets. We recommend that you plan for extra space in cable pathways during the initial installation to allow capacity for future cable additions.

For spacing factors please refer to the current version of the BS 7671 Wiring Regulations.

MT Code	Description	Weight kg/m
MT2/3616	Standard 100x35mm	0.55
MT2/3617	Standard 150x35mm	0.69
MT2/3618	Standard 200x35mm	0.83
MT2/3619	Standard 300x35mm	1.18
MT2/7389	Fast coupling 60x65mm	0.54
MT2/7248	Fast coupling 100x65mm	0.79
MT2/7249	Fast coupling 150x65mm	0.84
MT2/7250	Fast coupling 200x65mm	1.09
MT2/7251	Fast coupling 300x65mm	1.60
MT2/7394	Fast coupling 400x65mm	1.94
MT2/7395	Fast coupling 500x65mm	2.72
MT2/7396	Fast coupling 600x65mm	3.13
MT2/7397	Fast coupling 200x105mm	1.59
MT2/7398	Fast coupling 300x105mm	1.93
MT2/7399	Fast coupling 400x105mm	2.71
MT2/7400	Fast coupling 500x105mm	3.12
MT2/7401	Fast coupling 600x105mm	3.53

EMC and data

It is recommended to separate power and data circuits by a minimum of 20cm. (EN 50174-2)

Where power and data circuits must cross, this must be done at 90 degrees.

Wire Basket systems without electrical continuity do not protect against electromagnetic fields. Make sure electrical continuity is preserved by using the appropriate earth bonding accessories.

Electrical continuity

Our Fast-Coupling Wire Basket conforms to IEC 61537. The wire mesh basket has an impedance lower than:

- ⚡ 50mΩ across the joint
- ⚡ 5mΩ per metre in a straight section

Fire resistance

Marshall-Tufflex and Basor Electric certifies that the wire basket installed with the below mentioned characteristics complies with Class E90 of function maintenances, in accordance with Standard DIN 4102, Section 12.

This system incorporates Standard Wire Basket with a height of 65mm. This system uses Fast Fix Wall Bracket supports fixed to the wall and reinforced on the ceiling using the Variable Support Bracket, M8 Threaded Rod and M8 Nut on one side, as per the below image.



The distance between supports is of 1.2m and the maximum load is of 10kg/m. The system may have one or two levels.

Earth bonding

For earth bonding requirements please refer to the current version of the BS 7671 Wiring Regulations.

Cutting

Always use asymmetrical cut wire cutters. Cut as close as you can to where horizontal and vertical rods cross each other, as shown.

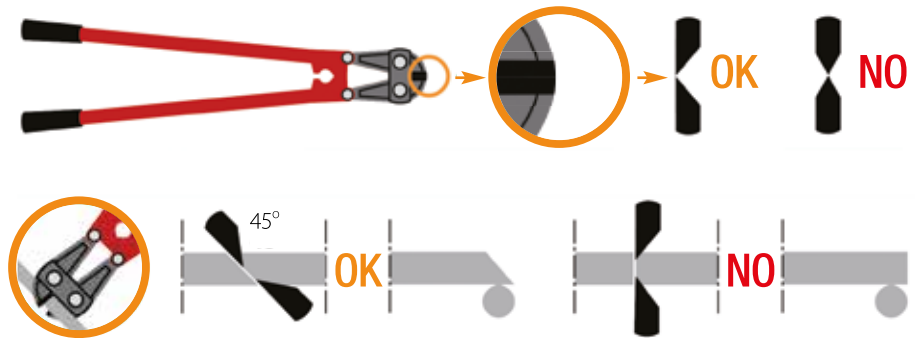

We recommend always placing the basket on a flat surface to make the cuts.

Wire gauge:

- 100mm - 200mm Width = 4.0mm
- 300mm - 400mm Width = 4.3mm
- 500mm - 600mm Width = 4.6mm

The below drawings show in red the section cuts that are needed for the bends, tees and changing levels as explained in the Installation section on pages 291-292.

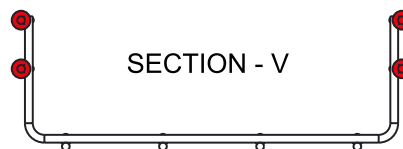
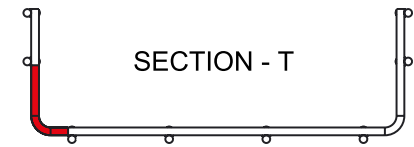
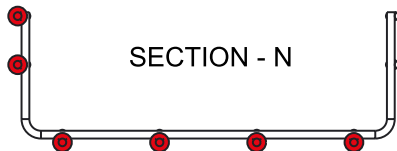
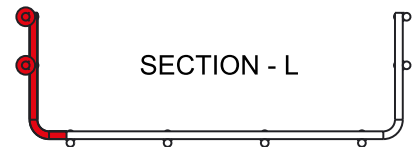
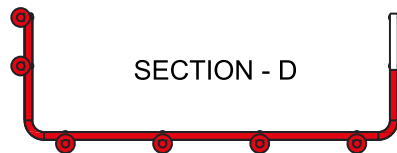

Installation

The following drawings show in red the sections that should be removed to make the associated join or bend.

Horizontal bend from two straight sections

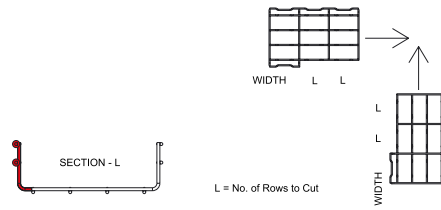
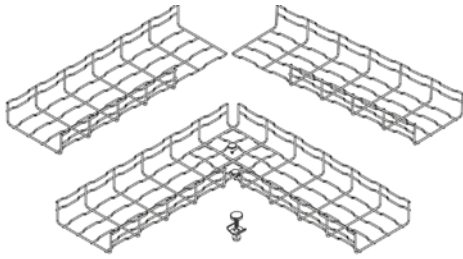

Horizontal bends long radius – right angle

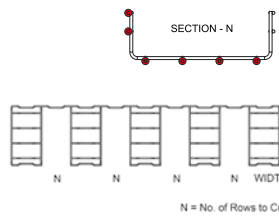
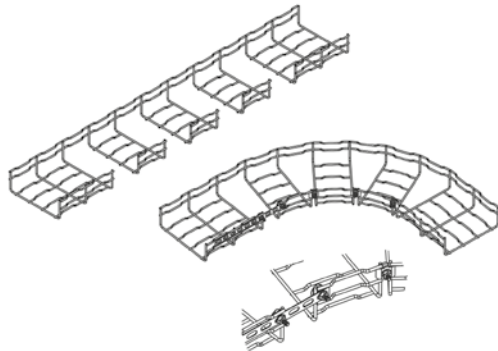

Horizontal tees

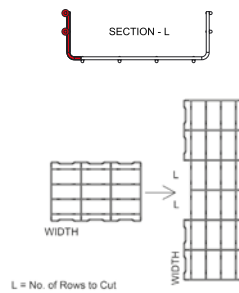
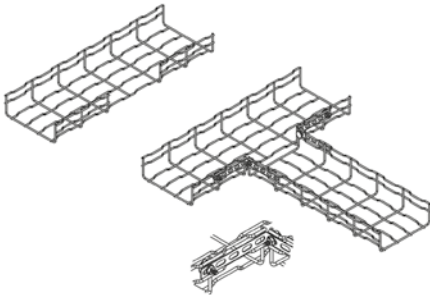

Tee with large radius

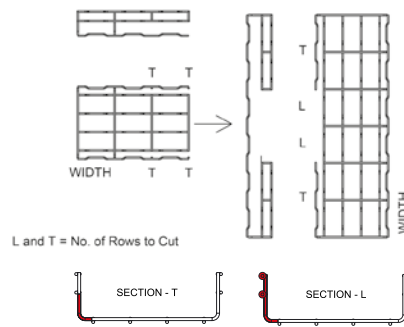
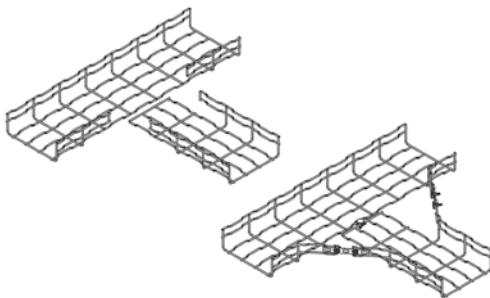

Vertical inside and outside bends

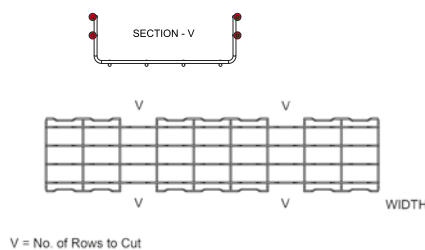
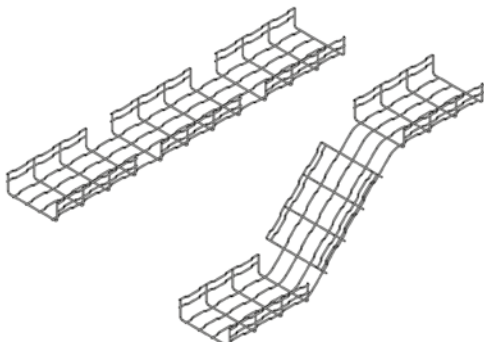

Reducers straight

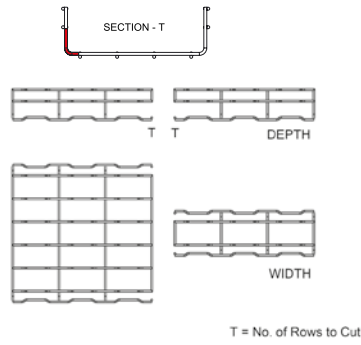
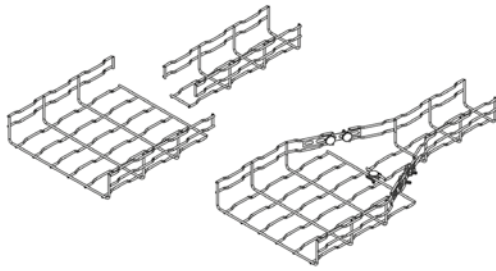

Reducers left or right

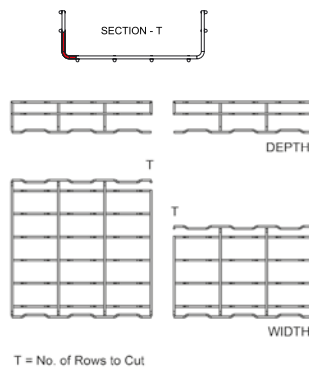
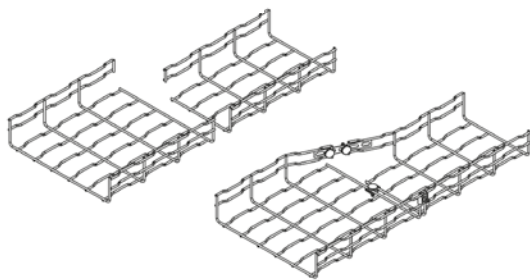

Vertical bends

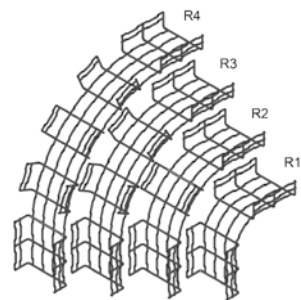
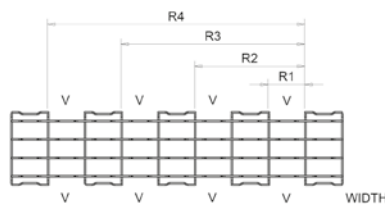
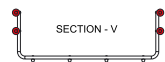
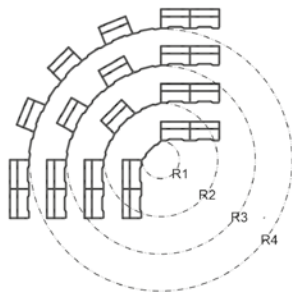

Radius	Radius diameter	Number of rows that will need to be cut
R1	64mm	1 row
R2	190mm	2 rows
R3	320mm	3 rows
R4	445mm	4 rows

Bio trunking

General information

Certain microbial organisms are harmful to people and can proliferate, via surfaces, to spread infection and disease. We have a responsibility to control such organisms wherever possible, particularly in environments such as hospitals, care homes, medical units, surgeries, schools, sports and health centres.

Microbial organisms can also cause product deterioration, discolouration and bad odours and antimicrobial treatments help to prevent these effects.

Marshall-Tufflex antimicrobial Bio trunking incorporates silver ions with the PVC-U compound, providing integral antimicrobial protection that prevents 99.9% of harmful bacteria growth.

Material – PVC-U

PVC-U is flame retardant and self-extinguishing. It is a 100% recyclable material. It complies with the requirements of BS 4761 Parts 6 and 7 and BS 7671:2018.

Material – silver ion additive

Silver ions have been proven to exert recognised bactericidal effect. When incorporated within materials such as PVC-U, silver is toxic to multiple components of bacterial cell metabolism, damaging the cell wall and membrane permeability.

PVC Material Test Results

LABORATORY Anti-Microbial Test Division, Kyoto Biseibutsu Kenkyusyo, Yamashina-ku, Kyoto 607-8482, Japan
TEST ORGANISM MRSA (Methicillin Resistant Staphylococcus aureus) Escherichia coli
STANDARD ISO 22196 / JIS Z 2801:2000

Quantitative Assessment of Activity - MRSA (Methicillin Resistant Staphylococcus aureus)				
	Number of live organisms (Colony Forming Units)		% reduction of Colony Forming Units, expressed as comparison with control	
	0 hours	24 Hours		
Control - Untreated polyethylene film	110,000	96,000	–	–
PVC	110,000	<10	>99.98% Reduction	VERY GOOD

Quantitative Assessment of Activity - Escherichia coli				
	Number of live organisms (Colony Forming Units)		% reduction of Colony Forming Units, expressed as comparison with control	
	0 hours	24 Hours		
Control - Untreated polyethylene film	110,000	14,000,000	–	–
PVC	110,000	<10	>99.99992% Reduction	EXCELLENT

ABS Material Test Results

LABORATORY Thomson Research Associates Inc., Ontario, Canada
TEST ORGANISM Klebsiella pneumonia, Staphylococcus aureus
STANDARD ISO 22196 / JIS Z 2801:2000

Quantitative Assessment of Activity - K. pneumoniae				
Concentration of starting inoculum		1.92 x 10 ⁵		
Sample Description	No. Bacteria Recovered	Log Value	R=[log(B/C)]	% Reduction
Inoculum Control	8.39 x 10 ⁶	6.9	–	–
ABS	<2.00 x 10 ¹	<1.3	>5.6	>99.9%

Quantitative Assessment of Activity - S. aureus				
Concentration of starting inoculum		1.92 x 10 ⁵		
Sample Description	No. Bacteria Recovered	Log Value	R=[log(B/C)]	% Reduction
Inoculum Control	1.00 x 10 ⁶	6.0	–	–
ABS	1.04 x 10 ²	2.0	4.0	>99.9%